

For the benefit and convenience of its customers, Fluke Corporation (Fluke) has reproduced this copy of a manual which is no longer in production. This manual has not been edited or updated since the revision date shown on the *lower left hand corner of the first page*. Fluke will not be liable for any claims, losses or damages of any kind incurred by any user arising from use of this manual.

8030A

Digital Multimeter

Instruction Manual

P/N 425942
August 1976
Revision 2 6/77

© 1981, John Fluke Mfg. Co., Inc., all rights reserved Litho in U.S.A.



WARRANTY

Notwithstanding any provision of any agreement the following warranty is exclusive:

The JOHN FLUKE MFG. CO., INC., warrants each instrument it manufactures to be free from defects in material and workmanship under normal use and service for the period of 1-year from date of purchase. This warranty extends only to the original purchaser. This warranty shall not apply to fuses, disposable batteries (rechargeable type batteries are warranted for 90-days), or any product or parts which have been subject to misuse, neglect, accident, or abnormal conditions of operations.

In the event of failure of a product covered by this warranty, John Fluke Mfg. Co., Inc., will repair and calibrate an instrument returned to an authorized Service Facility within 1 year of the original purchase; provided the warrantor's examination discloses to its satisfaction that the product was defective. The warrantor may, at its option, replace the product in lieu of repair. With regard to any instrument returned within 1 year of the original purchase, said repairs or replacement will be made without charge. If the failure has been caused by misuse, neglect, accident, or abnormal conditions of operations, repairs will be billed at a nominal cost. In such case, an estimate will be submitted before work is started, if requested.

THE FOREGOING WARRANTY IS IN LIEU OF ALL OTHER WARRANTIES, EXPRESS OR IMPLIED, INCLUDING BUT NOT LIMITED TO ANY IMPLIED WARRANTY OF MERCHANTABILITY, FITNESS, OR ADEQUACY FOR ANY PARTICULAR PURPOSE OR USE. JOHN FLUKE MFG. CO., INC., SHALL NOT BE LIABLE FOR ANY SPECIAL, INCIDENTAL, OR CONSEQUENTIAL DAMAGES, WHETHER IN CONTRACT, TORT, OR OTHERWISE.

If any failure occurs, the following steps should be taken:

1. Notify the JOHN FLUKE MFG. CO., INC., or nearest Service facility, giving full details of the difficulty, and include the model number, type number, and serial number. On receipt of this information, service data, or shipping instructions will be forwarded to you.
2. On receipt of the shipping instructions, forward the instrument, transportation prepaid. Repairs will be made at the Service Facility and the instrument returned, transportation prepaid.

SHIPPING TO MANUFACTURER FOR REPAIR OR ADJUSTMENT

All shipments of JOHN FLUKE MFG. CO., INC., instruments should be made via United Parcel Service or "Best Way" prepaid. The instrument should be shipped in the original packing carton; or if it is not available, use any suitable container that is rigid and of adequate size. If a substitute container is used, the instrument should be wrapped in paper and surrounded with at least four inches of excelsior or similar shock-absorbing material.

CLAIM FOR DAMAGE IN SHIPMENT TO ORIGINAL PURCHASER

The instrument should be thoroughly inspected immediately upon original delivery to purchaser. All material in the container should be checked against the enclosed packing list. The manufacturer will not be responsible for shortages against the packing sheet unless notified immediately. If the instrument is damaged in any way, a claim should be filed with the carrier immediately. (To obtain a quotation to repair shipment damage, contact the nearest Fluke Technical Center.) Final claim and negotiations with the carrier must be completed by the customer.

The JOHN FLUKE MFG. CO., INC., will be happy to answer all applications or use questions, which will enhance your use of this instrument. Please address your requests or correspondence to: JOHN FLUKE MFG. CO., INC., P.O. BOX C9090, EVERETT, WASHINGTON 98206, ATTN: Sales Dept. For European Customers: Fluke (Holland) B.V., P.O. Box 5053, 5004 EB, Tilburg, The Netherlands.

*For European customers, Air Freight prepaid.

John Fluke Mfg. Co., Inc., P.O. Box C9090, Everett, Washington 98206

Table of Contents

SECTION	TITLE	PAGE
1	INTRODUCTION AND SPECIFICATIONS	1-1
1-1	INTRODUCTION	1-1
1-6	SPECIFICATIONS	1-2
2	OPERATING INSTRUCTIONS	2-1
2-1	INTRODUCTION	2-1
2-3	SHIPPING INFORMATION	2-1
2-6	INPUT POWER	2-1
2-8	OPERATING FEATURES	2-1
2-10	OPERATING NOTES	2-1
2-12	Fuse Replacement	2-1
2-14	Overrange Indication	2-1
2-16	Input Overload Protection 	2-3
2-18	ASSEMBLY AND INITIAL OPERATION	2-3
2-22	FUNCTION SELECTION EXAMPLES	2-5
3	THEORY OF OPERATION	3-1
3-1	INTRODUCTION	3-1
3-3	OVERALL FUNCTIONAL DESCRIPTION	3-1
3-4	Introduction	3-1
3-6	Input Signal Conditioner	3-2
3-8	A/D Converter	3-2
3-10	Display	3-2
3-12	CIRCUIT DESCRIPTION	3-2
3-14	Signal Conditioning	3-2
3-34	A/D Converter	3-4
3-44	Display	3-4
3-55	Power Supply	3-5
4	MAINTENANCE	4-1
4-1	INTRODUCTION	4-1
4-4	GENERAL MAINTENANCE	4-2
4-5	Access Information	4-2
4-7	Cleaning	4-2
4-9	Fuse Replacement	4-2

(continued on page ii)

TABLE OF CONTENTS, *continued*

SECTION	TITLE	PAGE
4-11	PERFORMANCE CHECK	4-2
4-13.	DC Volts	4-2
4-15	AC Volts	4-3
4-17	Resistance Measurements	4-3
4-19.	Direct Current	4-3
4-21.	Alternating Current	4-3
4-23.	Diode Check	4-3
4-25.	CALIBRATION	4-3
4-28.	Required Method for Voltage Source Connection	4-4
4-31.	TROUBLESHOOTING	4-6
5	LIST OF REPLACEABLE PARTS	5-1
5-1.	INTRODUCTION	5-1
5-4.	HOW TO OBTAIN PARTS	5-1
6	OPTIONS & ACCESSORY INFORMATION	6-1
6-1.	INTRODUCTION	6-1
6-3.	RECHARGEABLE BATTERY PACK, 8040A-7005	6-1
6-4.	Introduction	6-1
6-6.	Operation	6-1
6-8.	BATTERY COVER KIT, 8040A-7004	6-1
6-10.	BATTERY COVER, 8040A-7007	6-1
6-12.	CARRYING CASE (C88)	6-1
6-14.	BATTERY CHARGER/ELIMINATOR	6-3
6-16.	TEMPERATURE PROBE (80T-150)	6-3
6-17.	Introduction	6-3
6-20.	Operating Notes	6-3
6-25.	Operating Instructions	6-3
6-27.	DELUXE TEST LEAD KIT (A80)	6-4
6-29.	CURRENT TRANSFORMER (80I-600)	6-4
6-30.	Introduction	6-4
6-32.	Operation	6-5
6-34.	CURRENT SHUNT (80J-10)	6-5
6-36.	HIGH VOLTAGE PROBE (80F-5)	6-5
6-37.	Introduction	6-5
6-41.	Cleaning	6-5
6-43.	Calibration	6-5
6-46.	HIGH VOLTAGE PROBE (80F-15)	6-6
6-47.	Introduction	6-6
6-51.	Cleaning	6-6
6-53.	Calibration	6-6
6-56.	HIGH VOLTAGE PROBE (80K-40)	6-7
6-57.	Introduction	6-7
6-60.	HIGH FREQUENCY PROBE (81-RF)	6-7
6-61.	Introduction	6-7
6-63.	HIGH FREQUENCY PROBE (82-RF)	6-7
6-64.	Introduction	6-7
7	SCHEMATIC DIAGRAM	7-1

Section 1

Introduction & Specifications

1-1. INTRODUCTION

1-2. The Model 8030A is a small ruggedly constructed digital multimeter especially suited for field service work. It features a bright 3-1/2 digit LED display with a slide out sunshade allowing instrument operation in adverse lighting conditions.

1-3. Pushbutton controls allow the selection of five ac and dc voltage ranges, five alternating and direct current ranges, and five resistance ranges. Measurement capabilities range from 100 microvolts to 1100 volts dc, 10 millivolts to 750 volts rms, and 100 milliohms to 1999 kilohms. In each range a blinking full scale readout indicates that the 8030A is being operated in an overrange condition.

1-4. Several options and accessories are available for use with the 8030A. The options and accessories are listed in Table 1-1. More information about the options and accessories is available in Section 6 of this manual.

1-5. Note that the temperature probe accessory can be ordered in one of two configurations, the 80T-150C (for reading in °C) or 80T-150F (for reading in °F). The battery charger/eliminator is made in five configurations to be compatible with various power sources. When ordering either of these accessories refer to Table 1-1 for the correct model number.

Table 1-1. Accessories

ACCESSORY	DESCRIPTION
80I-600	Clamp-on current transformer; 2 to 600 amps
80J-10	Current shunt; 10 amps
80F-5	High voltage probe; 5 kV.
80F-15	High voltage probe; 15 kV.
80K-40	High voltage probe; 40 kV.
81RF	High frequency probe; 20 kHz to 100 MHz
82RF	High frequency probe; 100 kHz to 500 MHz
80T-150C	Temperature probe; -50°C to +150°C
80T-150F	-58°F to +302°F
C88	Carrying case
A80	Deluxe test lead kit.
8040A-7004K	A battery cover kit; includes 4 "C" size alkaline batteries.
8040A-7005K	A rechargeable Ni Cad battery pack (batteries come secured in the battery cover).
8040A-7007K	A battery cover intended for use with alkaline batteries (batteries not included).
A81-115	Battery charger/eliminator for 115V, 48 to 62 Hz line source.
A81-100	Battery charger/eliminator for 100V, 48 to 62 Hz line source.
A81-220	Battery charger/eliminator for 220V, 48 to 62 Hz line source (European type plug CEE7)
A81-230-1	Battery charger/eliminator for 230V, 48 to 62 Hz line source (U.S. type plug)
A81-230	Battery charger/eliminator for 230V, 48 to 62 Hz line source (European type plug CEE7).
A81-230-3	Battery charger/eliminator for 240V, 48 to 62 Hz (U.K. type plug BS 1363)

1-6. SPECIFICATIONS**DC Voltage**

Ranges: ± 199.9 mV, ± 1.999 V, ± 19.99 V, ± 199.9 V, ± 1100 V
Accuracy: (1 year, 18°C to 28°C) $\pm(0.1\%$ of reading +1 digit)
Input Impedance: $10\text{ M}\Omega$, all ranges
Normal Mode Noise Rejection: Greater than 60 dB at 50 Hz, 60 Hz
Common Mode Noise Rejection: Greater than 120 dB at dc and at 50 Hz, 60 Hz
500V dc or peak ac continuous (1 k Ω in either lead)
Maximum Input: 1100V dc or peak ac (<10 seconds on 200 mV, 2V ranges)

AC Voltage (True rms)

Ranges: 199.9 mV, 1.999V, 19.99V, 199.9V, 750V
Accuracy: (1 year, 18°C to 28°C, from 100 digits to full range)
All ranges:
45 Hz—1 kHz $\pm(0.5\%$ of reading +2 digits)
20V range and below:
45 Hz—5 kHz $\pm(0.5\%$ of reading +2 digits)
5 kHz—10 kHz $\pm(2\%$ of reading +3 digits)
Input Impedance $10\text{ M}\Omega$ in parallel with less than 100 pf
Common Mode Noise Rejection: Greater than 60 dB at 50 Hz, 60 Hz (1 k Ω in either lead)
Crest Factor: From 1.0 to 3.0
Maximum Input: 750V rms or 1100V peak (<10 seconds on 200 mV, 2V ranges)

DC Current

Ranges: ± 199.9 uA, ± 1.999 mA, ± 19.99 mA, ± 199.9 mA, ± 1999 mA
Accuracy: (1 year, 18°C to 28°C) $\pm(0.35\%$ of reading +1 digit)
Voltage Burden: 0.25V max. except 0.7V max. on 2000 mA range
Maximum Input: 2A rms (fuse protected)

AC Current (True rms, ac + dc)

Ranges: 199.9 uA, 1.999 mA, 19.99 mA, 199.9 mA, 1999 mA
Accuracy: (1 year, 18°C to 28°C, from 100 digits to full range)
200 mA range and below:
45 Hz to 5 kHz $\pm(1\%$ of reading +2 digits)
2000 mA range:
45 Hz to 2 kHz $\pm(3\%$ of reading +2 digits)
Voltage Burden: 0.25V rms max. except 0.7V rms max. on 2000 mA range
Maximum Input: 2A rms (fuse protected)
Crest Factor: From 1.0 to 3.0

Resistance

Ranges: 199.9 Ω , 1.999 k Ω , 19.99 k Ω , 199.9 k Ω , 1999 k Ω
Accuracy: (1 year, 18°C to 28°C) $\pm(0.4\%$ of reading +1 digit) except 2000k range, $\pm(0.6\%$ reading +1 digit)
Voltage Across Unknown: 0.2V at full range, all ranges
Maximum Current Through Unknown: 1 mA (on 200 Ω range)
Maximum Input Voltage: 250V rms (<5 seconds on 200 Ω , 2 k Ω ranges) 130V rms continuous 200 Ω , 2 k Ω ranges

Diode Test

Range: 0 to 2000 mV at 1 mA test current
Accuracy: (1 year, 18°C to 28°C) $\pm(0.2\%$ of reading +1 digit)
Maximum Input Voltage: 130V rms (250V rms for 5 seconds)

General

Maximum Common Mode Voltage: 500V dc or peak ac
Operating Temperature Range: 0°C to +50°C
Temperature Coefficients: (0°C to 18°C, 28°C to 50°C) <0.1 of applicable accuracy spec per °C
Storage Temperature Range: 40°C to +70°C (without batteries), -40°C to +50°C (with batteries)
Relative Humidity: 0 - 80% to 35°C, 0 - 70% to 50°C

Power Requirements:
Line: 100 (90-110) / 115 (104-126 / 220 (198-242) / 230 (207-253) / 240 (216-264) V, 48-66 Hz, 1W (instrument only), 8W (charging)

Battery: **Rechargeable**—Ni Cad pack (8 hour typical operation from full charge, recharge time 14 hours typical at ambient temperature <30°C to achieve full charge)
Non-rechargeable—4 alkaline "C" cells provide 10 hour operation (typical)

Size: 64 mm high x 145 mm long x 124 mm wide (2.5" x 5.7" x 4.9")
Weight: 1.0 kg (2.2 lbs)

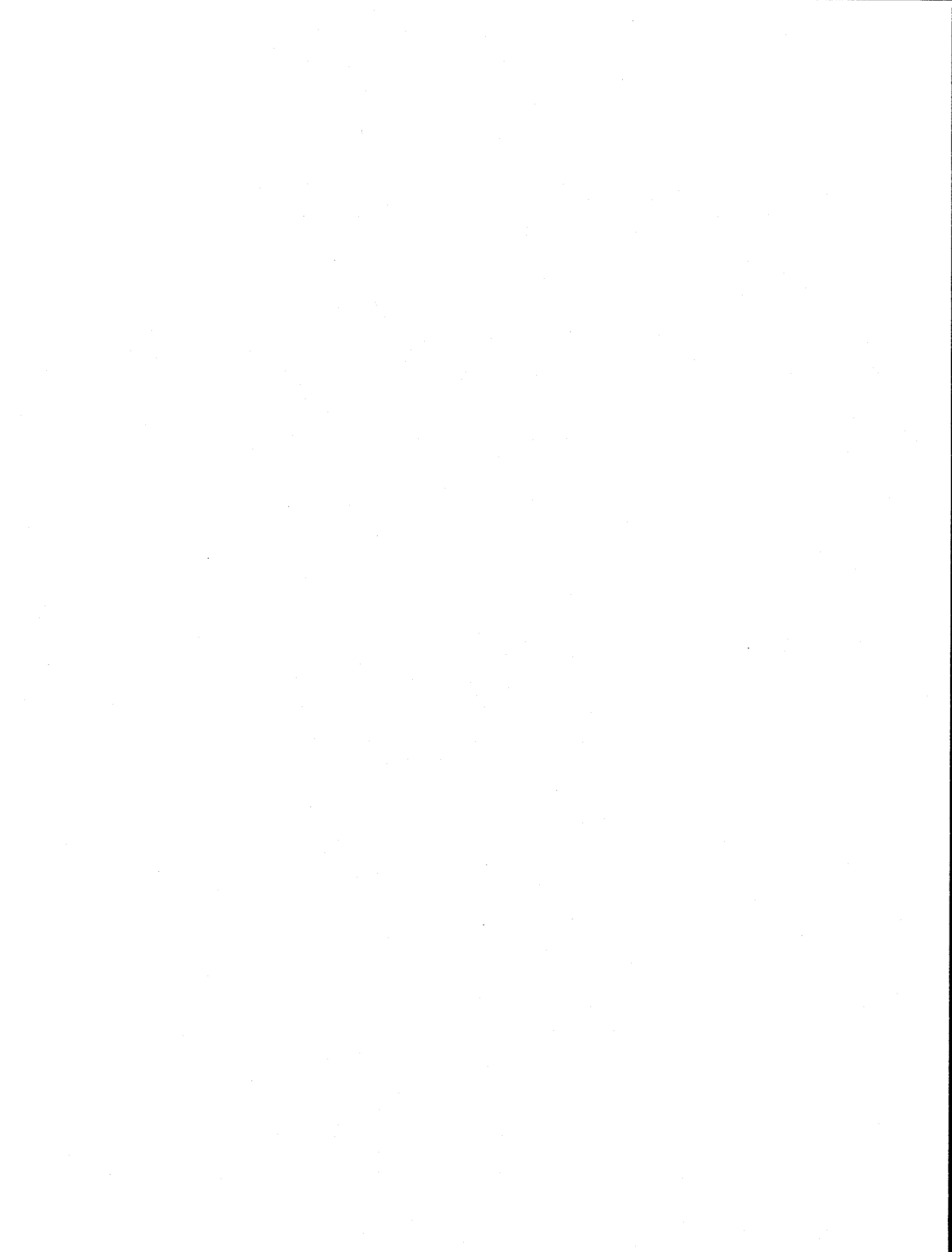

Section 2

Operating Instructions

2-1. INTRODUCTION

2-2. This section of the manual contains information regarding the correct operation of the Model 8030A Multimeter. It is recommended that the contents of this section be read and understood before attempting to operate the instrument. Should any difficulties arise during operation, please contact your nearest John Fluke Sales Representative, or the John Fluke Mfg. Co., Inc., P.O. Box 43210 Mountlake Terrace WA, 98043, Telephone (206) 774-2211. A list of sales representatives is located at the back of this manual.

2-3. SHIPPING INFORMATION

2-4. The 8030A was packed and shipped in a foam container especially designed to provide adequate protection. Upon receipt, inspect the instrument for possible shipping damage.

2-5. If reshipment of the instrument is necessary, the original container should be used. If the original container is not available, a new one can be obtained from the John Fluke Mfg. Co., Inc. Please reference the instrument model number when requesting a new shipping container.

2-6. INPUT POWER

2-7. Operating power for the standard 8030A instrument comes from four, non-rechargeable, alkaline "C" size batteries. This power source typically provides 10 hours of instrument operation. Optionally available power sources include rechargeable Ni-cad batteries and a battery charger/eliminator. The instrument equipped with rechargeable batteries will typically operate for 8 hours; recharging, using the charger/eliminator, takes approximately 14 hours (at ambient temperatures $<30^{\circ}\text{C}$ to achieve full charge).

WARNING

THE LOW LEAD CONNECTING THE CHARGER/ELIMINATOR TO THE 8030A WILL BE AT A VOLTAGE POTENTIAL EQUAL TO THAT APPLIED TO THE COMMON TERMINAL. DO NOT USE ANY CHARGER/ELIMINATOR OTHER THAN THE ONE SPECIFIED IN TABLE 1-1.

2-8. OPERATING FEATURES

2-9. The location of the 8030A controls, indicators, and connectors is shown in Figure 2-1. A description of the control, indicator, or connector is provided in Table 2-1.

2-10. OPERATING NOTES

2-11. The following paragraphs describe various conditions which should be considered before operating the 8030A.

2-12. Fuse Replacement

2-13. The 8030A is equipped with a current overload fuse to protect the instrument circuitry from inadvertent applications of current in excess of 2 amps. This fuse is located behind the mA input jack and is removed by pressing in lightly on the jack then turning it counter-clockwise 1/4 turn to release. When replacement is necessary, use a 2 amp AGX replacement fuse.

2-14. Overrange Indication

2-15. When the full scale capability of the selected range for any function is exceeded, the display will blink. The overrange indication does not necessarily mean that the instrument is being exposed to a damaging input condition.

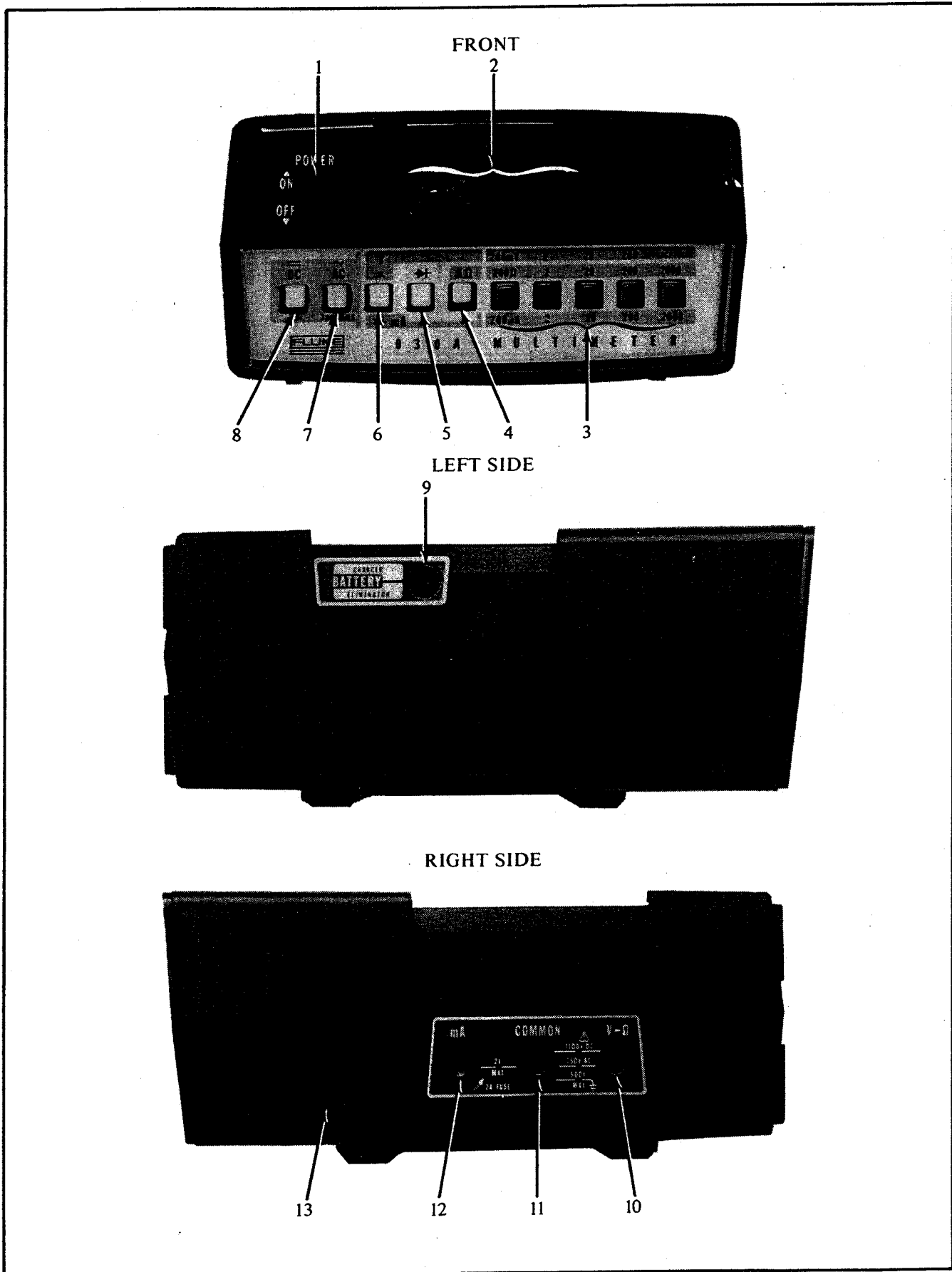

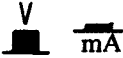



Figure 2-1. Control, Indicator and Connector Locations

Table 2-1. Control, Indicator and Connector Description

ITEM NUMBER	NAME	DESCRIPTION
1	POWER switch	Separates the power source (batteries or battery eliminator) from 8030A circuitry
2	Display	A 3½ digit display (1999 maximum) of the measured input, including decimal point and polarity sign when appropriate.
3	Range switches	Provide pushbutton selection of one of five ranges for each function i.e. DC Voltage: 200 mV, 2, 20, 200, or 1100V AC Voltage: 200 mV, 2, 20, 200, or 750V rms AC or DC Current: 200 uA, 2, 20, 200, or 2000 mA Resistance: 200Ω, 2, 20, 200, or 2000 KΩ
4	KΩ	Selects resistance measurement mode of operation.
5	 Diode Test	Provides 1 mA of current through the test leads. The display indicates the voltage developed across the unknown P/N junction i.e.; a forward biased diode.
6		Works in conjunction with the DC and AC switches to select the voltage function (out position) or current function (in position).
7	 AC	This switch in conjunction with item 6 selects ac voltage or alternating current measurement capability.
8	 DC	This switch in conjunction with item 6 selects dc voltage or direct current measurement capability.
9	BATTERY CHARGER/ ELIMINATOR	Jack provided for connection of the charger/eliminator accessory.
10	V-Ω	Jack for high (red) lead connection to 8030A for voltage (ac or dc) and resistance measurements.
11	COMMON	Jack for low (black) lead connection to 8030A for all functions.
12	mA	Jack for high (red) lead connection to 8030A for current (ac and dc) measurements (2A FUSE behind; push in and twist to remove).
13	Sunshade	Shade slides forward to improve the readability of the display in bright light environments.

2-16. Input Overload Protection

CAUTION

Exceeding the maximum input overload conditions can damage the 8030A. Read Tables 2-2 before attempting to operate the instrument.

2-17. The overload protection varies with the range and function selected. The maximum allowable input overload condition for each function and range is given in Table 2-2.

2-18. ASSEMBLY AND INITIAL OPERATION

2-19. It is recommended that the assembly and initial operation of the 8030A be done in accordance with the

Table 2-2. 8030A Maximum Allowable Input Overload Conditions

SELECTED FUNCTION	SELECTED RANGE	INPUT CONNECTIONS	MAXIMUM INPUT OVERLOAD LIMITS
VDC	200 mV, 2V	V- Ω and COMMON	500V dc or V rms (continuous) 1100V dc or Peak ac (for less than 10 sec.)
	20, 200, 1100V	V- Ω and COMMON	1100V dc or Peak ac
DC mA	200 μ A, 2, 20, 200, or 2000 mA	mA and COMMON	2 amp, 250V Fuse Protected
VAC	200 mV, 2V	V- Ω and COMMON	500V rms, 1100V Peak, or 500V dc (continuous) 750V rms (for less than 10 sec.)
	20, 200, 750V	V- Ω and COMMON	750V rms, 1100V Peak, or 500V dc
AC mA	200 μ A, 2, 20, 200, or 2000 mA	mA and COMMON	2 amp, 250V Fuse Protected
k Ω	200 Ω , 2 K Ω	V- Ω and COMMON	130V rms or dc (continuous) 250V rms or dc (for 5 sec)
	20, 200, 2000	V- Ω and COMMON	250V rms or dc

following procedure. No test equipment is required to perform this procedure; all signals observed are generated by the 8030A. This procedure may be used as an instrument operational evaluation when the 8030A is being used in locations away from normal calibration equipment.

2-20. Assemble the 8030A as follows:

- a. Remove the contents of the box marked BATTERY COVER. (Four "C" size batteries, a battery cover, and two mounting screws for non-rechargeable batteries; four "C" size batteries mounted in the battery cover and two mounting screws for rechargeable batteries.)

CAUTION

Do not operate 8030A without battery cover in place.

- b. The four non-rechargeable alkaline batteries are to be mounted in the battery clips (position as indicated on 8030A case) then the battery cover secured in place with the two screws provided. When installing the rechargeable battery pack note the guide tab on the edge of the cover and match it with the recess in the bottom center of the 8030A case.

2-21. The following procedure may be used to check the basic operation of the 8030A. It is not intended to be used as a verification of calibration accuracy. Proceed with the operational check as follows:

- a. Turn the 8030A on.
- b. Connect the red test lead to the V- Ω input terminal.
- c. **(Check DC Volts Operation)** Select volts dc function (see Function Selection Examples) and the 20 range.
- d. Insert the probe of the test lead into the BTRY TEST hole located on the bottom of the 8030A case.
- e. The 8030A display will indicate the battery voltage; between 4.0 volts and 5.8 volts.
- f. **(Check AC Volts Operation)** Select the volts ac function and 200 mV range.
- g. The 8030A display will indicate the ripple voltage created by the inverter. This voltage will be as much as 60 millivolts (battery operation) or 130 mV with the charger/eliminator as power source.

NOTE

Due to the charging of the input coupling capacitor it will take 5 to 10 seconds for this reading to settle.

- h. **(Check Resistance Operation)** Select the resistance function and 2 range.
- i. Place the test probe tip into the mA input terminal.
- j. The 8030A display will indicate 0.100 +2 digits.
- k. **(Check DC mA Operation)** Connect the red test lead to the mA input terminal.
- l. Select the dc mA function and 2 range.
- m. Place the test probe tip into the BTRY TEST hole.
- n. The 8030A display will indicate between 0.400 and 0.580 milliamps. (The current depends upon the battery voltage measured in step d and e.)
- o. **(Check AC mA Operation)** Select the ac mA function.

- p. The 8030A display will indicate the same as step n (mA input is dc coupled).
- q. **(Check Diode Test Operation)** Select the diode test function and 2 range.
- r. Connect the red test lead to the V-Ω input terminal.
- s. Place the test probe tip into the mA input terminal.
- t. The 8030A display will indicate 100 ±2 digits (1 mA of current through 100 ohms).
- u. Select the 200Ω range.
- v. The 8030A display will indicate approximately 990.

2-22. FUNCTION SELECTION EXAMPLES

2-23. Figure 2-2 provides a graphic illustration of switch positions and input connections for each 8030A function.

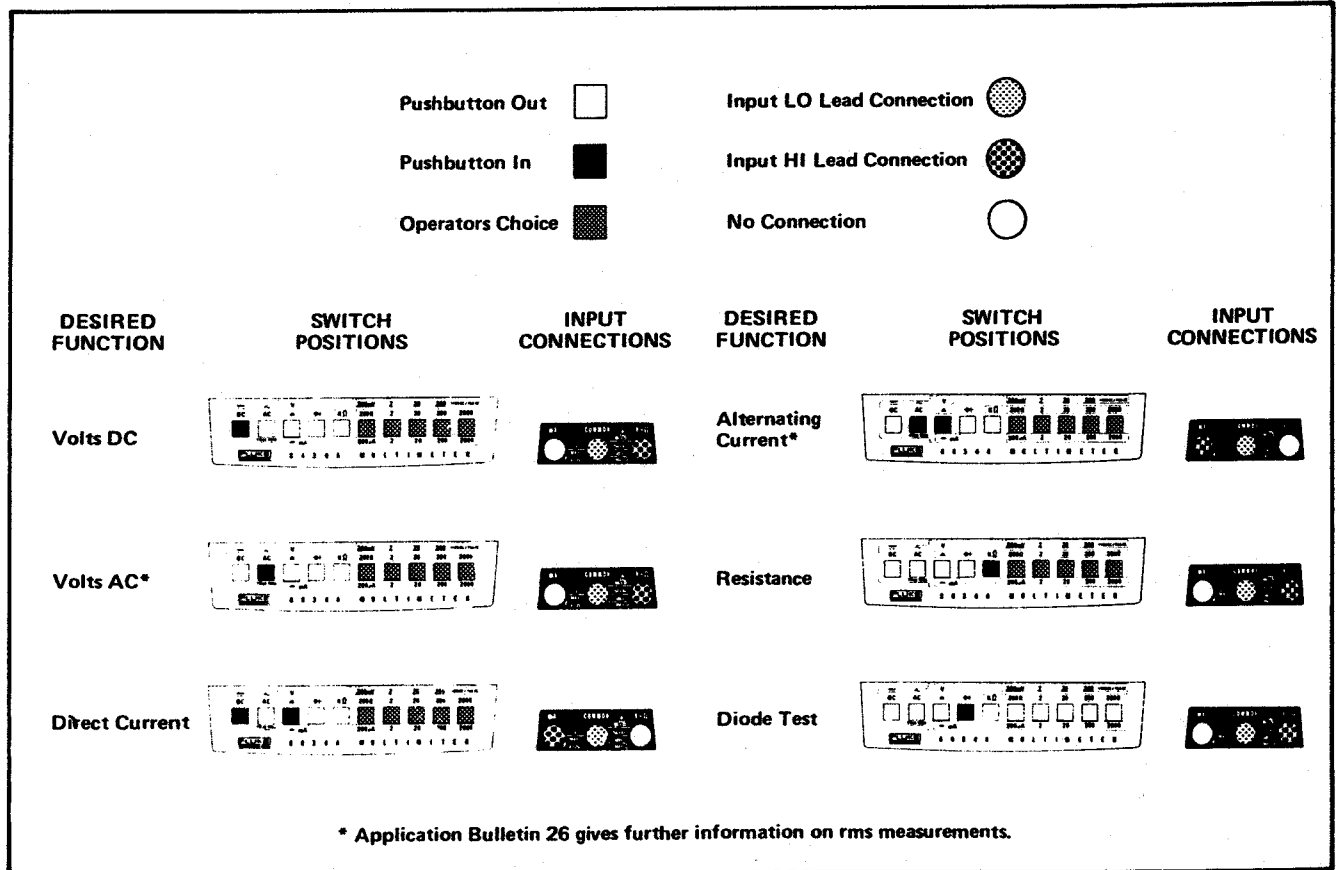

Figure 2-2. Function Selection Examples



Section 3

Theory of Operation

3-1. INTRODUCTION

3-2. The theory of operation for the Model 8030A is arranged under two major headings. The first, titled **OVERALL FUNCTIONAL DESCRIPTION**, discusses the overall operation of the instrument in terms of the functional relationships of the major circuits. The second section is titled **CIRCUIT DESCRIPTION** and deals with the internal operation of each major circuit in more detail. Block diagrams and simplified circuit diagrams are included, where needed, to aid in understanding the theory. The complete schematic diagram is located in Section 7.

3-3. OVERALL FUNCTIONAL DESCRIPTION

3-4. Introduction

3-5. The 8030A circuitry can be divided into three major sections; Input Signal Conditioner, Analog to Digital (A/D) Converter, and Display. The interconnection of these three sections is illustrated in Figure 3-1. The functional relationship of the three major sections will be discussed first, followed by a more detailed look at what is contained in each section.

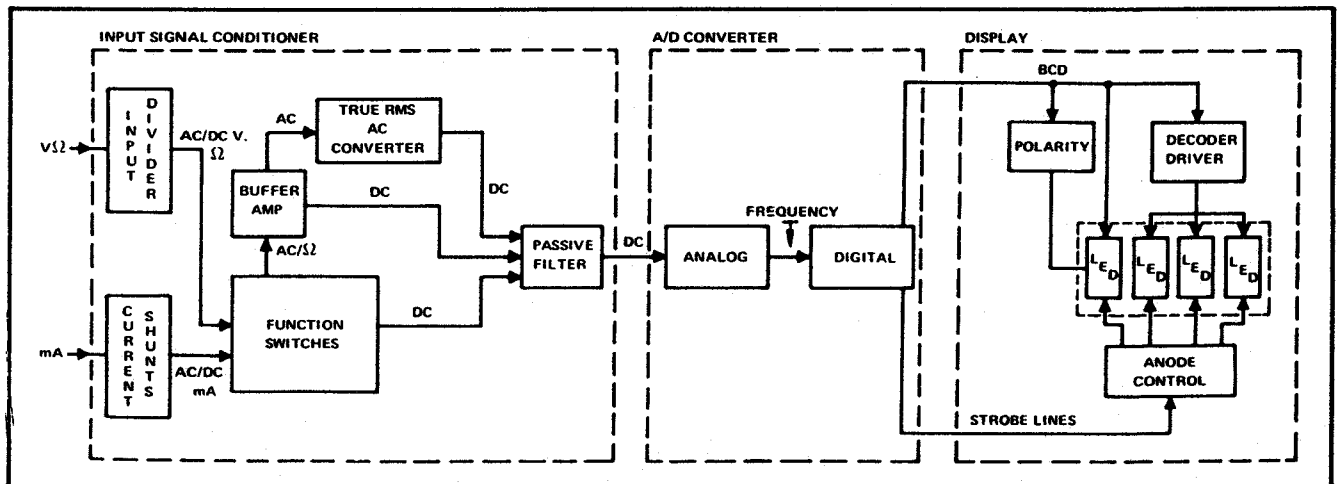

Figure 3-1. Model 8030A Block Diagram

3-6. Input Signal Conditioner

3-7. The function of the Signal Conditioner is to condition the applied inputs, according to the function selected, to provide a dc output voltage which is directly proportional to the applied input. The output voltage will be, depending on the range selected, from 0 to +0.2V dc or 0 to +2.0V dc. The range switches select portions of the Input Divider or Current Shunts to scale the input signal to a level which is acceptable for the selected function. The function switches place the Signal Conditioner in the configuration necessary to process the input signal.

3-8. A/D Converter

3-9. The A/D Converter changes the analog dc output voltage of the Signal Conditioner into a digital representation. This is accomplished in two stages using a voltage-to-frequency converter (Analog IC) and a digital counter/processor (Digital IC). The A/D Converter also controls the measurement and display period of the 8030A.

3-10. Display

3-11. The Display section of the 8030A accepts digital information from the A/D Converter and presents it as a numeric representation of the value of the applied input signal. The display is updated each time the A/D Converter samples the applied input.

3-12. CIRCUIT DESCRIPTION

3-13. The following circuit descriptions are keyed to the functional blocks defined in the simplified block diagram of Figure 3-1. The reference designators referred to in the circuit descriptions correspond to the designators on the detailed schematics found in Section 7 of this manual.

3-14. Signal Conditioning

3-15. INPUT VOLTAGE DIVIDER

3-16. Resistor network U1 contains three series connected resistors (U1-A, U1-B and U1-C) of 9.9 megohms, 90 kilohms, and 10 kilohms respectively. In the lower two ranges (200 mV and 2) the Input Divider is bypassed, in the 20 and 200 ranges the divider ratio is 100 to 1 and in the 2000 range the ratio is 1000 to 1. Fixed capacitors C2, C6, C12, C13 and C19 plus trimmer capacitor C11 are connected across the divider to maintain a flat frequency response.

3-17. CURRENT SHUNTS

3-18. The current shunts consist of resistors R19, R20, and R21 plus two in resistor network U4. The series connected resistors total 1000 ohms. When a range switch

is pressed, switch contacts select one of five points in the resistor string to provide 1000, 100, 10, 1 and 0.1 ohms of resistance for the 200 μ A, 2, 20, 200 and 2000 mA ranges respectively.

3-19. The maximum voltage developed across a single shunt resistor or combination of shunt resistors for full range indication is 0.2 volts. Current overload protection for inputs above 2 amperes is provided by fuse F1. The shunts are protected against over-voltage by diodes CR3 and CR4.

3-20. FUNCTION SWITCHES

3-21. The voltages that result from inputs applied to the Input Divider or Current Shunts may be either ac or dc. The Function switches direct the resulting dc voltages directly to the A/D Converter while the resulting ac voltages go through the Buffer Amp to the AC Converter. Contacts of the Function switches direct the voltage to the correct place.

3-22. BUFFER AMPLIFIER

3-23. The Buffer Amplifier is used as a current source in the $k\Omega$ function and as a variable gain ($\times 1$ or $\times 10$) amplifier in the ac volts and alternating current modes of operation. The buffer consists of Q2 and U6. Solid state switches in U5 select the buffer gain.

3-24. When used as a current source in the $k\Omega$ function, the Buffer Amplifier is configured as indicated in Figure 3-2. The buffer supplies a dc voltage proportional to the unknown resistance (R_X), to the A/D Converter. Operational amplifier U6 bootstraps the current source. With the non-inverting input connected to the junction of R_A and R_X , current will flow through R_A and R_X such that a constant voltage is maintained across R_X for a given range. If R_X is within the range selected, the voltage developed will be proportional to the value of R_X . For resistance ranges of 200 Ω and 200 $k\Omega$ the voltage across R_A will be 10 volts. All other ranges result in 1 volt across R_A .

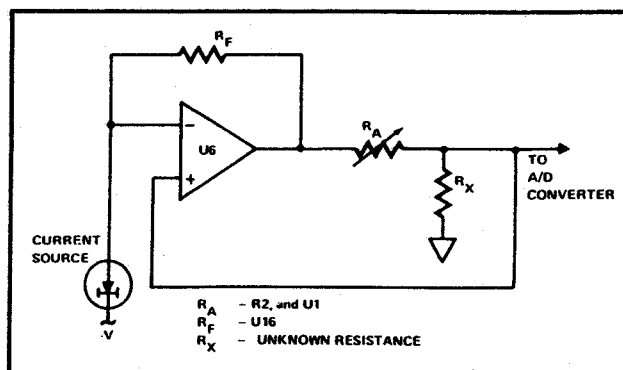

Figure 3-2. Buffer Amplifier for $K\Omega$ Function

3-25. In the Diode Test mode of operation the Buffer Amplifier provides approximately a 1 mA current output at the V-Ω terminal. The voltage developed across the dynamic resistance of a pn junction(s) is displayed, in millivolts, on the 8030A.

3-26. The Buffer Amplifier configuration for ac voltage and alternating current inputs is illustrated in Figure 3-3. The gain of the amplifier is changed from X10, for the 200 mV and 20 ranges, to X1 for the remaining ranges. The output of operational amplifier U6 will be 2 volts when the input applied to the 8030A is full scale on any range; i.e., 2 volts on 2 range, 20 volts on 20 range, etc.

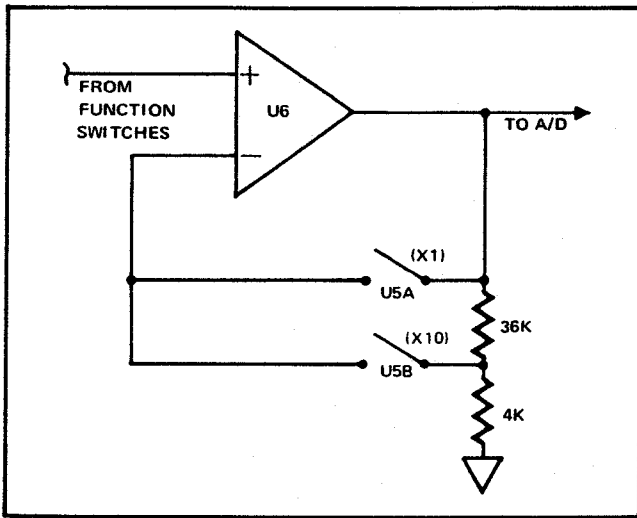

Figure 3-3. Buffer Amplifier for AC Volts and AC mA

3-27. TRUE RMS AC CONVERTER

3-28. The AC Converter computes the true rms value of the 8030A ac input voltage. The rms value of the input

signal is equal to the square root of the absolute value of the average voltage input squared. Expressed as a formula; $V_{rms} = \sqrt{V_{in}^2}$. The circuitry in the AC Converter can be broken into four sections, each performing one of the four calculation steps. Figure 3-4 is a simplified schematic diagram which identifies the four areas.

3-29 The absolute value of the applied signal is obtained by combining two signals at the input of U7A. One path for the input signal, through R27, applies a full wave signal to U7A with the amplitude determined by the value of R27. The second signal path, through U3 and associated components, creates a half wave signal with a peak amplitude twice that of signal through R27. The combination of the two inputs results in a full wave rectified input to U7A.

3-30. The squaring circuit, U7A and two transistors of U17, utilize the logarithmic voltage-current characteristic of a p-n junction to square the absolute value circuit output. The output voltage of U7A will be proportional to two times the log of the current flow (determined by the absolute value circuit) across the two transistors.

3-31. The square root and averaging circuits work together to perform the remaining calculation of the true rms value. The output of U2A is applied to the base of one of the U17 transistors and the value of this base drive signal is determined by the current through R41. The emitter of the U17 transistor is driven by the current output of U7A (squaring circuit output). The collector current resulting from the base and emitter drive signals is proportional to the square root of the current flowing in the squaring circuit. The calculations are complete and the resulting output of U7B represents the true rms value of the applied input.

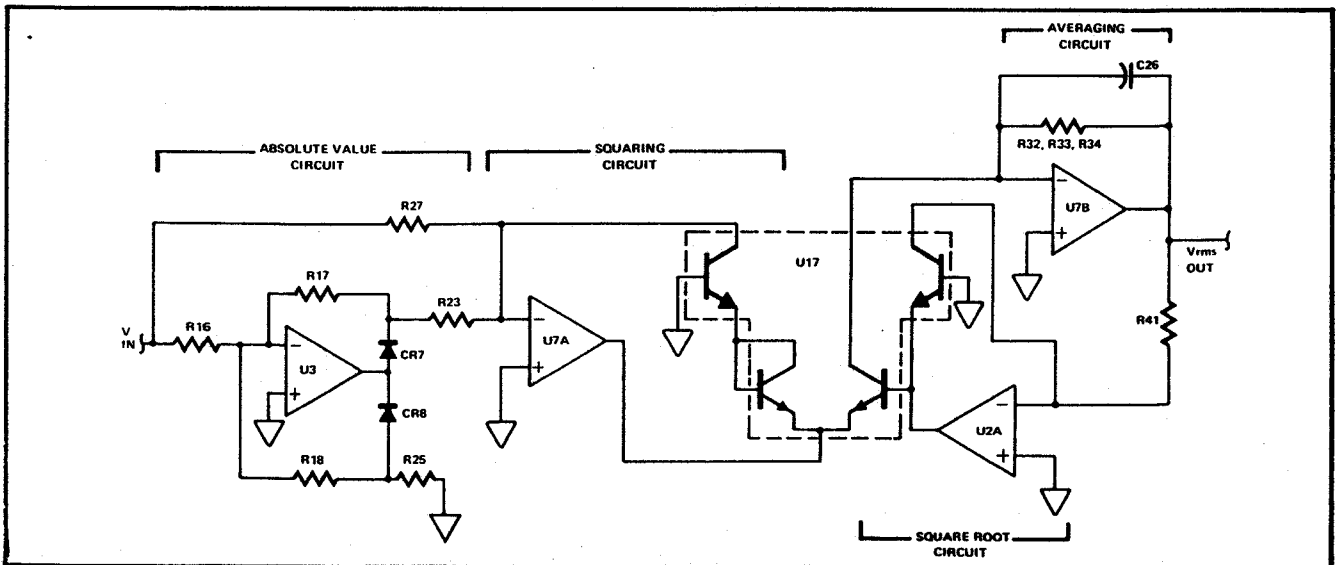

Figure 3-4. True RMS AC Converter

NOTE

Since the 8030A is a true rms responding instrument the display will indicate a reading (typically 10 digits) when the input is shorted in the ACV or ACI functions. The accuracy of the 8030A is not significantly affected by this internal offset when measuring inputs that are at least 5% of the selected range (100 digits). When the rms value of the two values (internal offset and 5% of range) is calculated the minimal effect is shown.

$$V_{rms} = \sqrt{10^2 + 100^2} = 100.5$$

3-32. PASSIVE FILTER

3-33. The dc voltages representing the different inputs are passed through a Passive Filter, comprised of C23, C24, R26 and R37, before they are applied to the A/D Converter. This filter removes any ac component from dc input voltage to prevent the display from showing excessive instability in the least significant digit.

3-34. A/D Converter**3-35. GENERAL**

3-36. The A/D Converter uses a voltage-to-frequency conversion technique. A dc voltage at the input of the A/D Converter is changed to a frequency by the Analog Integrated Circuit. This frequency is characteristic of the magnitude and polarity of the dc input voltage. Counting of the output frequency from the Analog IC is accomplished by the Digital IC. The resultant count is transferred (in binary coded decimal format) to the display section.

3-37. ANALOG IC

3-38. The Analog IC is an LSI device which contains a two-input multiplexer, an amplifier, and a voltage controlled oscillator (VCO). In operation, the Analog IC samples between a reference voltage (0V dc) and the output of the Passive Filter (0 to +0.2 or 0 to +2V dc) to provide two separate output frequencies. The difference between the two frequencies is an accurate digital representation of the input voltage. This A/D conversion technique automatically eliminates the zero-offset errors which are inherent in many A/D converters. For example, if the VCO rest frequency is 80 kHz during the reference sample and a 0V dc input is present during the voltage sample, the output of the VCO does not change. No change is equal to 0V dc. Therefore, as long as the oscillator does not drift during the two sample periods a zero-offset error cannot exist.

3-39. The range resistor, in Figure 3-5, symbolizes the dual range capability of the Analog IC. This resistance, external to the IC, consists of series — parallel resistors R56, R59 and R57, R60. When the instrument is in the 2 volt basic range, R56 and R59 are used to scale the current to the V/F Converter. Variable resistor R56 is the calibration adjustment for this range. For operation in the 0.2 volt basic range, the switching disconnects R56 and R59 and places R57 and R60 in the circuit.

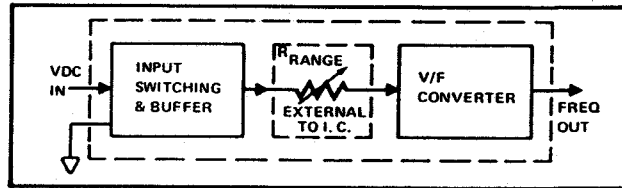

Figure 3-5. Analog IC Block Diagram

3-40. Timing circuitry for the A/D Converter is contained in the Analog IC. The connection between the Analog IC and the Digital IC is through R58, Q5, R47, C30 and adjustment R46.

3-41. DIGITAL IC

3-42. The output from the Analog IC alternates between the rest frequency during one time period, and a frequency corresponding to the A/D Converter input voltage during the next time period. Reversible counters in the Digital IC count these frequencies such that their difference is used to provide the BCD measurement information.

3-43. A four-line BCD output (W-X-Y-Z on schematic) and a four-line strobing pulse output (S1-S2-S3-S4 on schematic) are provided by the Digital IC to the Display section. The BCD lines W-X-Y-Z correspond to binary 8-4-2-1 positions, respectively.

3-44. Display**3-45. POLARITY**

3-46. The polarity indicator consists of horizontal and vertical LED segments of DS1. These segments are strobed during the S1 time period, when the instrument is in the DCV or DC mA function. The horizontal segment is used alone for a negative indication, and together with the vertical segment to build a positive indication. Consequently, the horizontal segment must illuminate during each S1 time period.

3-47. DECODER DRIVER

3-48. The Decoder Driver, U10, translates the BCD information on the W-X-Y-Z lines for application to the

LED readouts DS2, DS3 and DS4. Low inputs are provided by the Decoder Driver through a resistor network U11 to the LED segments for construction of decimal numbers.

3-49. DECIMAL POINT

3-50. The LED readouts DS2, DS3 and DS4 contain a decimal point which is controlled by the RANGE switches. The selected range causes the resistor network U13 to supply a ground connection to the cathode of the decimal segment.

3-51. ANODE CONTROL

3-52. The Anode Control circuit, Q10 through Q13 and U12 applies +5V dc to the anodes of the LED readouts. Strobe pulses from the Digital IC determine which readout receives the proper anode voltage at a particular time. The strobe pulse sequence is S1-S3-S2-S4, yielding a display sequence of DS1-DS3-DS2-DS4. For example: when S2 goes high, U12 and Q10 turn-on and apply approximately +5V dc to the anodes of the LED segments on DS2. Those segments with ground connections on their cathodes, at S2 time, will illuminate and form a decimal number.

3-53. LED READOUTS

3-54. The LED readouts DS2, DS3 and DS4 each contain 7½ diode segments. One-half of a segment for a decimal point and seven segments to form decimal numbers. The segments are designated A through G for each readout on the schematic.

3-55. Readout DS1 indicates the most significant digit (MSD) and polarity. Two segments form a numerical "1" and two segments to form the polarity signs. Control of the MSD "1" indication is separate from the other readouts. The BCD information is produced on the Z line during the S1 time period. When line Z is high during time S1, U12 turn on to allow the "1" segment to illuminate.

3-55. Power Supply

3-57. The power supply, shown in the schematic in Section 8, provides ±14V and +5V dc outputs. The +5V is taken directly from the battery or charger/eliminator. The ±14V dc is produced in the inverter circuitry comprised of Q6, Q7, T1 and associated components.



Section 4

Maintenance

WARNING!

THESE SERVICING INSTRUCTIONS ARE FOR USE BY QUALIFIED PERSONNEL ONLY. TO AVOID ELECTRIC SHOCK, DO NOT PERFORM ANY SERVICING OTHER THAN THAT CONTAINED IN THE OPERATING INSTRUCTIONS UNLESS YOU ARE QUALIFIED TO DO SO.

4-1. INTRODUCTION

4-2. This section of the manual contains information on service, general maintenance, performance tests, calibration, and troubleshooting. The performance test is recommended as a preventative maintenance tool, and should be executed when it is necessary to verify proper

instrument operation. A calibration interval of one year is recommended to insure that the 8030A performs within the specifications stated in Section 1.

4-3. Table 4-1 lists the recommended test equipment necessary to maintain the 8030A. If the specified equipment is not available, other equipment having equivalent specifications may be used.

Table 4-1. Recommended Test Equipment

EQUIPMENT NOMENCLATURE	SPECIFICATIONS	RECOMMENDED EQUIPMENT
DC Voltage Source	190 mV to 1200V $\pm 0.03\%$	Fluke Model 341A
DC Current Source	190 μ A to 1.9A $\pm 0.1\%$	Fluke Model 382A
AC Voltage Source	190 mV to 1200V (45 Hz to 10 kHz) $\pm 0.1\%$	Fluke Models 5200A/5205A
Resistors	190 Ω to 1.9 M Ω in 10 Ω steps, 0.04% accuracy	ESI Model DB 62
Frequency Counter	To measure positive 100 ms pulse with 1 μ s resolution	Fluke Model 1953A
Oscilloscope	General Purpose	Tektronix 545B W/1A1 plug-in
DMM	To measure 1.0 mV dc	Fluke Model 8030A

4-4. GENERAL MAINTENANCE

4-5. Access Information

4-6. Use the following procedure to gain access to the interior of the 8030A:

1. Set the POWER switch to OFF and disconnect the battery charger/eliminator, if attached.
2. Remove the fuse from the mA jack (press in, turn counterclockwise 1/4 turn to release).
3. Remove the two screws holding the battery retainer to the rear of the instrument and remove the retainer and batteries.

NOTE

The rechargeable batteries are secured to the battery retainer and are removed as one unit. The non-rechargeable batteries, however, are not secured so the battery retainer should be removed when the instrument is sitting on the work bench face down.

4. Remove the screw from the center of the rear panel of the instrument case and slide the 8030A out of the case.

NOTE

Do not attempt to remove the sunshade when the 8030A is in the case. The sunshade does not have to be removed to slide the instrument out of the case.

CAUTION

There are two wires connecting the 8030A circuitry to the battery contacts in the case. Use care not to place excessive strain on these wires.

5. Unplug the battery power wires from the 8030A circuit board.
6. Depress the DC and 2000 pushbuttons.
7. Remove the two screws securing the circuit board to the BOTTOM of the front panel.
8. Lay the 8030A upside down on a flat surface and gently pull the PCB (with switches attached) straight back away from the front panel and unfold the PCB out flat.

CAUTION!

Do not bend the circuit board backwards past the flat position as damage to the flex joints may occur.

4-7. Cleaning

4-8. Clean the front panel and case with denatured alcohol or a mild solution of detergent and water. Clean dust from the circuit board with low pressure dry air. Contaminates can be washed from the circuit board with demineralized water and a soft brush (avoid getting excessive amounts of water on the switches).

CAUTION!

Do not use aromatic hydrocarbons or chlorinated solvents for cleaning. These solutions will react with the plastic materials of the instrument.

4-9. Fuse Replacement

4-10. A fuse, located behind the mA input jack, provides protection against current inputs that exceed 2 amps. When replacement is required, use only a AGX 2 amp fuse as a replacement. This fuse is removed by pressing in on the mA input terminal then turning it counterclockwise 1/4 turn to release.

4-11. PERFORMANCE CHECK

4-12. The performance check provides a means of verifying the overall operation of the 8030A. This procedure can be used as an acceptance test for receiving inspection and as a periodic maintenance check. Refer to Table 4-1 for the test equipment recommended for these checks. Should the 8030A fail to meet the requirements of these checks calibration and/or troubleshooting will be necessary. See Table 4-1 for recommended calibration equipment.

4-13. DC Volts

4-14. This procedure requires the output of a dc voltage source (see Table 4-1), set to specified levels, to be applied to the 8030A V-Ω and COMMON input while the display is observed to be within specific limits. This procedure is to be performed in an environment of 23±5°C with relative humidity less than 80%. Refer to Table 4-2 for the dc performance check.

Table 4-2. DC Voltage Performance Check

8030A RANGE	DC VOLTS INPUT	8030A DISPLAY LIMITS
200 mV	190.0 mV	189.7 to 190.3
2	1.900V	1.897 to 1.903
2	0.900V	0.898 to 0.902
20	19.00V	18.97 to 19.03
20	9.00V	8.98 to 9.02
200	190.0V	189.7 to 190.3
200	50.0V	49.8 to 50.2
1100 dc	1000V	998 to 1002
1100 dc	450V	448 to 452

4-15. AC Volts

4-16. During this procedure ac voltage levels at specified frequencies are applied to the 8030A V- Ω and COMMON inputs and the display observed to be within specific limits. Perform this procedure under environmental conditions of $23 \pm 5^\circ\text{C}$ at relative humidity less than 80%. Refer to Table 4-3 for the ac performance check.

Table 4-3. AC Voltage Performance Check

8030A RANGE	AC VOLTS INPUT	INPUT FREQ.	8030A DISPLAY LIMITS
200 mV	190.0 mV	50 Hz	188.8 to 191.2
200 mV	190.0 mV	5 kHz	188.8 to 191.2
200 mV	190.0 mV	10 kHz	185.9 to 194.1
2	1.900V	50 Hz	1.888 to 1.912
2	1.900V	5 kHz	1.888 to 1.912
2	1.900V	10 kHz	1.859 to 1.941
20	19.00V	50 Hz	18.88 to 19.12
20	8.00V	5 kHz	7.94 to 8.06
20	19.00V	10 kHz	18.59 to 19.41
200	190.0V	50 Hz	188.8 to 191.2
200	190.0V	1 kHz	188.8 to 191.2
750	750V	50 Hz	744 to 756
750	750V	1 kHz	744 to 756

NOTE

Since the 8030A is a true rms responding instrument the display will indicate a reading (typically 10 digits) when the input is shorted in the ACV or ACI functions. The accuracy of the 8030A is not significantly affected by this internal offset when measuring inputs that are at least 5% of the selected range (100 digits). When the rms value of the two values (internal offset and 5% of range) is calculated the minimal effect is shown.

$$V_{rms} = \sqrt{10^2 + 100^2} = 100.5$$

4-17. Resistance Measurements

4-18. This procedure calls for precision resistance to be applied to the 8030A V- Ω and COMMON inputs and the display observed to be within specified limits. This procedure is to be performed in an environment of $23 \pm 5^\circ\text{C}$ with relative humidity less than 80%. Refer to Table 4-4 for the resistance performance check.

4-19. Direct Current

4-20. This procedure calls for known values of direct current to be applied to the 8030A mA and COMMON inputs and the display observed to be within specified limits. This procedure is to be performed in an

environment of $23 \pm 5^\circ\text{C}$ with relative humidity less than 80%. Refer to Table 4-5 for the direct current check.

Table 4-4. Resistance Performance Check

8030A RANGE	RESISTANCE INPUT	8030A DISPLAY LIMITS
200 Ω	SHORT	00.0 to 00.1
200 Ω	OPEN	199.9 (Flashing)
200 Ω	190.0 Ω	189.1 to 190.9
2	1.900k	1.891 to 1.909
2	0.100k	.099 to .101
20	19.00k	18.91 to 19.09
20	2.00k	1.98 to 2.02
200	190.0k	189.1 to 190.9
200	80.0k	79.6 to 80.4
2000	1900k	1888 to 1912
2000	200k	198 to 202

Table 4-5. Direct Current

8030A RANGE	DIRECT CURRENT INPUT	8030A DISPLAY LIMITS
200 μA	190.0 μA	189.2 to 190.8
2	1.900 mA	1.892 to 1.908
20	19.00 mA	18.92 to 19.08
200	190.0 mA	189.2 to 190.8
2000	1900 mA	1892 to 1908

4-21. Alternating Current

4-22. The alternating current mode of operation need not be checked because the accuracy of the shunts is established by the direct current check and the frequency response is determined by the ac converter which is checked during the ac voltage check. In addition it is difficult to find a source of alternating current, covering this frequency band, accurate enough to be used for calibration.

4-23. Diode Test

4-24. In the diode test mode the 8030A provides a 1 mA current output at the V- Ω terminal. This output is checked by placing a known resistance between the V- Ω terminal and the COMMON terminal and observing the display for a reading in millivolts. Perform the Diode Test check as follows:

1. Select the Diode Test function by pressing the " " pushbutton.
2. Connect 1.900 k Ω resistance (use the recommended decade resistor box to insure the accuracy of the resistance) between the V- Ω and COMMON terminals.

3. Observe the 8030A display to read between 1895 and 1905.

4-25. CALIBRATION

4-26. Calibration of the Model 8030A should be done after repairs have been made to the electronic circuitry or when the performance check indicates the unit is not operating within the specification. Table 4-1 provides a list of test equipment required to calibrate this instrument. These procedures should be performed under environmental conditions of $23 \pm 5^\circ\text{C}$ at a relative humidity of less than 80%.

4-27. It is recommended that the 8030A circuit board remain folded up and attached to the front panel. All adjustments and test points are accessible through the open sides of the folded up unit. The location of each calibration adjustment is illustrated in Figure 4-1. The steps of this procedure must be performed in the order presented.

NOTE

The physical position of some components may affect the ac calibration of the instrument. Avoid moving the components, especially after the calibration procedure has been completed.

4-28. Required Method for Voltage Source Connection

4-29. When a DMM is opened for servicing, the voltage source connections to it must be made in the manner shown in Figure 4-2. This method is required for PERSONAL SAFETY. Since a DMM has no earth ground connection in itself, the earth ground connection must be supplied from the voltage source. The earth

ground connection will insure that voltage potential, harmful to the calibration or repair technician, will not be present on the instrument's common circuits.

WARNING

INSURE THAT THE VOLTAGE SOURCE CONNECTION METHOD ILLUSTRATED IN FIGURE 4-2 IS USED. OTHER CONNECTION METHODS MAY CAUSE HAZARDOUS VOLTAGES TO BE PRESENT ON THE 8030A COMMON CIRCUITS.

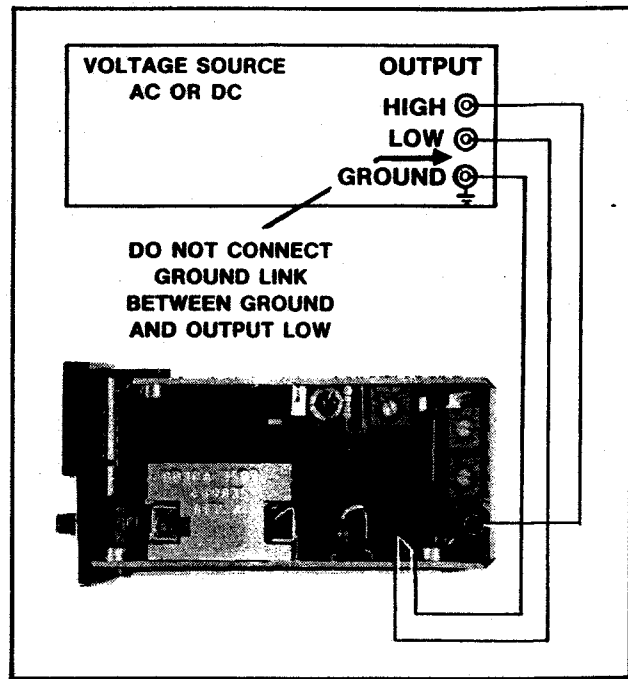

Figure 4-2. Required Method for Voltage Source Connection

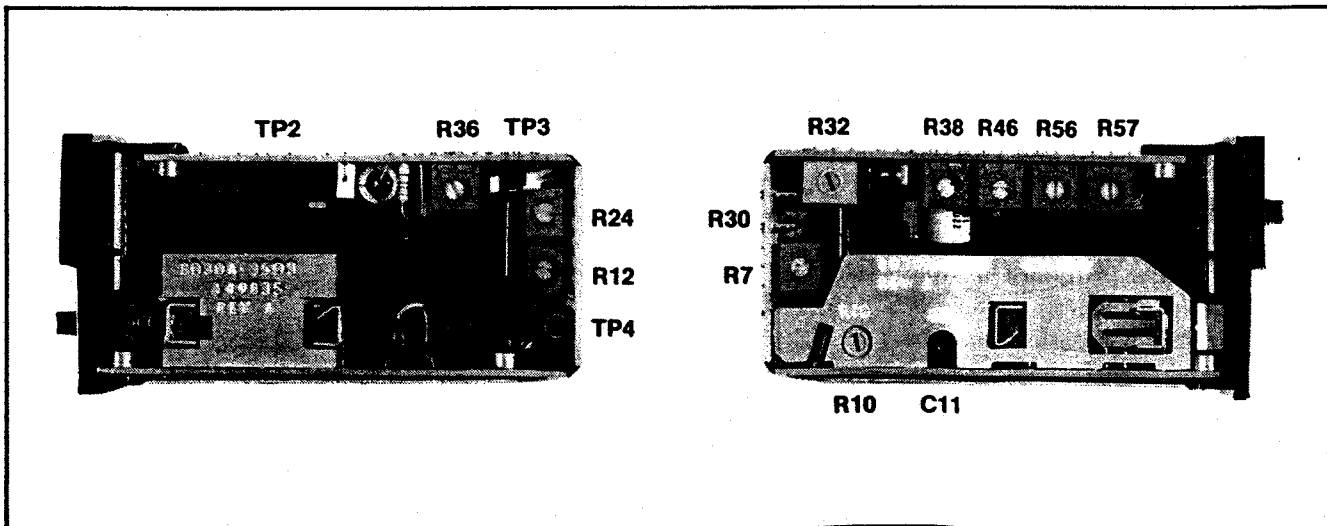

Figure 4-1. Calibration Adjustment Location

4-30. Allow the 8030A to warm up for 5 minutes then perform the calibration as follows:

1. Connect the frequency counter to TP2. Set the counter controls to measure the time interval of the positive-going pulse at TP2.
2. Adjust R46 for a counter display of 99,995 to 100,005 microseconds.
3. Disconnect the frequency counter.
4. On the 8030A front panel select DC volts function and 200 mV range.
5. Place a short between the V- Ω and COMMON terminals.
6. Adjust R38 for a 8030A display of 00.0, alternately indicating the + and - polarity signs.
7. Remove the short from the input.
8. Apply +0.190 volts dc to the 8030A input terminal.
9. Adjust R57 for a 8030A display of exactly +190.0.
10. Reverse the input voltage polarity (-0.190 volts).
11. Adjust R38 for -190.0 \pm 1 digit.
12. Place a short between the V- Ω and COMMON terminals. Check the display for 00.0 alternately indicating the + and - polarity signs.

NOTE

Occasional indication of a 1 in the least significant digit is permissible.

13. Remove the short.
14. Select the "2" range.
15. Apply +1.900 volts dc to the input terminals.
16. Adjust R56 for an 8030A display of exactly +1.900. Disconnect the voltage source.
17. Select the AC volts function and 20 range.
18. Short the V- Ω terminal to the COMMON terminal.

6-77

19. Connect a multimeter, set to read dc mV, to TP3.
20. Adjust R7 for a reading of 0.0 ± 3 mV as indicated on the test equipment multimeter display.
21. Select the 2 range.

NOTE

R12 and R24 are interacting adjustments.

22. Turn R30 fully clockwise and R24 fully counter-clockwise.
23. Connect a multimeter to TP4 (use a 1 to 10 k Ω isolating resistor at the multimeter probe tip).
24. Adjust R12 for a -0.2 to -0.4V dc indication on the test equipment multimeter.
25. Note the 8030A display reading.
26. Adjust R24 clockwise until the 8030A display increments 1 digit.
27. Adjust R12 for a voltage at TP4, as indicated on the test equipment multimeter, of 0.00 ± 0.15 V dc.
28. Repeat steps 26 and 27 until the display remains incremented 1 digit and TP4 reads 0.00 ± 0.15 V dc.
29. Remove the multimeter from TP4 and the short from the input.

NOTE

R30 and R32 are interacting adjustments.

30. Apply 190.0 mV ac at 1 kHz to the V- Ω terminal.
31. Adjust R30 for an 8030A display of $.190 \pm .001$.
32. Change the applied input to 1.900V ac at 1 kHz.
33. Adjust R32 for an 8030A display of $1.900 \pm .001$.
34. Repeat steps 30 through 33 until the displays for each input are exactly .190 and 1.900.
35. Apply the inputs indicated in Table 4-6 and make the associated range selections.

NOTE

When the 8030A is placed back into the case the resulting change in the position of the ac shield may cause a shift in the ac calibration. Check 19.0V ac at 5 kHz again after replacing the case (19.00 ± 0.03), and if necessary slide the 8030A out of the case and readjust C11.

Table 4-6. AC Voltage Calibration

RANGE	INPUT	ADJUST	READING
AC/V/2	1.90V 5 kHz	Check	1.895 to 1.905
AC/V/2	1.90V 10 kHz	Check	1.880 to 1.920
AC/V/200 mV	190 mV 100 Hz	Check	189.5 to 190.5
AC/V/200 mV	19.0 mV 100 Hz	Check	18.9 to 19.1
AC/V/200 mV	190 mV 5 kHz	Check	189.5 to 190.5
AC/V/200 mV	190 mV 10 kHz	Check	188.0 to 192.0
AC/V/20	19.0V 100 Hz	Check	18.97 to 19.03
AC/V/20	19.0V 5 kHz	C11	19.00 Exactly
AC/V/20	19.0V 10 kHz	Check	18.80 to 19.20
AC/V/200	190.0V 100 Hz	Check	189.5 to 190.5
AC/V/200	190.0V 1 kHz	Check	189.5 to 190.5
AC/V/750	750.0V 100 Hz	Check	747 to 753
AC/V/750	750.0V 1 kHz	Check	747 to 753

NOTE

Since the 8030A is a true rms responding instrument the display will indicate a reading (typically 10 digits) when the input is shorted in the ACV or ACI functions. The accuracy of the 8030A is not significantly affected by this internal offset when measuring inputs that are at least 5% of the selected range (100 digits). When the rms value of the two values (internal offset and 5% of range) is calculated the minimal effect is shown.

$$V_{rms} = \sqrt{10^2 + 100^2} = 100.5$$

36. Apply the resistances indicated in Table 4-7 and make the associated range selections and adjustments as called for.

Table 4-7. Resistance Calibration

RANGE	INPUT	READING
k Ω /200	190 k Ω	Adjust R36, 200 k Ω Cal, for exactly 190.0.
k Ω /2	1.9 k Ω	Adjust R10, 2 k Ω Cal, for exactly 1.900
k Ω /200 Ω	SHORT	00.0 to 00.1
k Ω /200 Ω	OPEN	199.9 Flashing
k Ω /200 Ω	190 Ω	189.8 to 190.2
k Ω /20	19 k Ω	18.98 to 19.02
k Ω /2000	1.900 M Ω	1897 to 1903

37. Apply the values of direct current indicated in Table 4-8, select the appropriate range and observe the 8030A for a display within the limits given.

Table 4-8. DC mA Calibration

RANGE	INPUT	READING
DC/mA/200 μ A	+190 μ A	+189.5 to 190.5
DC/mA/2	+1.9 mA	+1.895 to 1.905
DC/mA/20	+19.0 mA	+18.95 to 19.05
DC/mA/200	+190 mA	+189.5 to 190.5
DC/mA/2000	+1.9A	+1895 to 1905.

4-31. TROUBLESHOOTING

4-32. The following information should be kept in mind while doing repair work on the 8030A. Inattention to these precautions may lead to instrument damage.

- MOS type integrated circuits can be damaged by discharging static electricity through the device. Integrated circuits U5, U8 and U9 are susceptible to damage when they are not installed on the PCB. Use care when removing or replacing these components. Always use a grounded soldering iron when removing or installing MOS devices.
- The 8030A uses flexible connectors for physical and electrical connection of the individual printed circuit boards. These flexible connectors should never be unfolded past the flat position. Reverse flexing of the connectors will damage the solder joints.
- The physical position of some components may affect the ac calibration of the instrument. The position of capacitors C1, C2, C6, C11, C12, C13, and C19, and resistor network U1, all of which are in the input circuit, are most likely to change the calibration if their positions were changed.
- The low side of the charger, eliminator connector will always be at the same voltage, with respect to earth ground, as the COMMON input terminal.

4-33. A troubleshooting guide for the 8030A is presented in Table 4-9. This guide is in a tabular-flow chart form and is recommended for use in isolating a problem to a functional circuit area. The initial steps in the troubleshooting guide refer to checks made in the Assembly and Initial Operation procedure in Section 2. Make the observations about the instrument operation as required by each step of the troubleshooting guide.

NOTE

Perform steps 1 through 6 in order, noting the ones that result in NO answer. This will provide a good understanding of the instrument operation prior to actual troubleshooting.

NOTE:

When troubleshooting the power supplies, power the instrument from a charger/eliminator.

Table 4-9. Troubleshooting Guide (continued)

STEP	INSTRUCTION	YES	NO	GO TO
1	Does the 8030A pass the DC Volts Check in paragraph 2-21?	2	8/37	
2	Does the 8030A pass the AC Volts Check in paragraph 2-21?	3	27	
3	Does the 8030A pass the Resistance Check in paragraph 2-21?	4	46	
4	Does the 8030A pass the DC mA Check in paragraph 2-21?	5	58	
5	Does the 8030A pass the AC mA Check in paragraph 2-21?	6	63	
6	Does the 8030A pass the Diode Test Check in paragraph 2-21?	7	64	
7	No malfunction indicated by this test.		23	
8	Is the voltage at the BTRY TEST point 4.6 to 5.3 VDC?	10	9	
9	Check the charger/eliminator or the power supply Q7, VR7 and associated circuitry.			1
10	Are the power supply voltages correct?			
	a. +14 at junction of CR13 and C34: 13 to 15 VDC	14	11	
	-14 at junction of CR12 and C35: -13 to -15 VDC			
	b. +6.8 at cathode of VR2: 6.0 to 7.1 VDC	14	13	
	-6.8 at cathode of VR1: -6.0 to -7.1 VDC			
11	Unsolder the anode of CR12 and the cathode of CR13. Is the voltage at the unsoldered ends of the diodes approximately 25 to 35 VDC?	12	9	
12	Re-solder, CR12 and CR13 and look for a warm (shorted) IC, calibration pot or other component.			1
13	Check VR1, VR2 or U5.			
14	Is the time interval measured at TP2 approximately 100 msec? (See the calibration procedure step 1 and 2)	16	15	
15	Check U8, U9, Q5 and associated circuitry.			1
16	Are all 4 display digits malfunctioning?	17	18	
17	Check CR14, U8, U9, U10, or U12.			
18	Is only one digit malfunctioning?	19	20	
19	The probable cause for the malfunction would be the individual display LED (DS1, DS2, DS3 or DS4), the respective strobe drivers (Q10, Q11, Q12 or Q13) or the transistor array U12 or resistor network U13.			1
20	Are 3 digits malfunctioning?	21		
21	Check U9, U10, or U11			1
22	Select the DC volts function and the 2 range. Apply + 1.000 VDC to the V- Ω input terminal. Does the 8030A read 1.0 VDC?	23	24	
23	Perform the complete calibration procedure and then the initial operation procedure again.			
	NOTE			
	<i>Should the 8030A fail to calibrate, the function selected as well as the particular adjustment that fails to meet the specified tolerance may point to the inoperative circuitry.</i>			
24	Is the voltage at U8 pin 16 1 VDC? (Use a voltmeter with an input impedance > 1000 M Ω)	25	26	
25	With the power switch off, DC V function and 2 range selected, and the input shorted, check the resistance between U8 pins 2 and 13; should be \approx 2 k Ω .			
26	Trace the signal path from the input jack checking for 1.0 VDC.			
27	Select ACV 20 range, short the input and monitor the voltage at TP3. Does R7 adjust TP3 for 0 \pm .003 VDC?	32	28	
28	Is the voltage at U2 pin 7 + 6.0 to 7.1 VDC?	30	29	
29	Check VR2, U2B or U5.			1
30	Is the voltage at U5 pin 5 + 6.0 to 7.1 VDC and U5 pin 13 -6 to 7.2 VDC?	34	31	

Table 4-9. Troubleshooting Guide (concluded)

STEP	INSTRUCTION	YES	NO	GO TO
31	Check U5, VR1 and VR2.			1
32	Select ACV 2 with the input shorted. Is the voltage at TP3 $0 \pm .003$ VDC?	35	33	
33	Replace Q2.			1
34	Check Q1, Q2, U5, U6, VR1, VR2 and associated circuitry.			1
35	Select ACV 2, set R12, R24 and R30 to the center of their adjustment range and apply 1.0 VAC 1 kHz. Is the DC voltage at U7 pin 7 approximately 1 volt?	36	37	
36	Check U5C, R44.			1
37	Is the input signal present at the SID side of R4?	39	38	
38	Check the input circuitry.			1
39	Is the input signal present at TP3?	41	40	
40	Check U6 and associated circuitry.			1
41	Are the half wave rectified portions of the input signal present at the cathode of CR7 and the anode of CR8?	43	42	
42	Check U3 and associated circuitry.			1
43	Is there an inverted full wave rectified signal riding on about -1 VDC at U7A pin 1?	45	44	
44	Check U7A, VR4 and U17.			1
45	Check U17, U7B, U2A, R32, R33 and R34.			1
46	Select ACV 20, short the input and monitor the voltage of TP3. Can R7 adjust TP3 for $0 \pm .003$ VDC?	47	35	
47	Select ACV 2 with the input shorted. Is the voltage at TP3 $0 \pm .003$ VDC?	49	48	
48	Replace Q2			1
49	Select $k\Omega$ 200 or 200Ω and short the input. Is the voltage at TP3 +10 VDC?	55	50	
50	Is U5 pin 12 between +6.0 and 7.1 VDC?	52	51	
51	Check U5 and VR2.			1
52	Is the voltage drop across R35 approximately 5.8 VDC?	54	53	
53	Check Q3, VR6 and associated circuitry.			1
54	Check U16.			55
55	Select $k\Omega$ 2, 20, or 2000 and short the input. Is the voltage at TP3 +1 VDC?	56	57	
56	Check Q1 and Q2.			1
57	Check the S6C, S9A and S4C switch connections.			1
58	Is fuse F1 blown?	59	60	
59	Replace fuse F1.			
60	Select $200 \mu A$ dc and apply $\pm 100m$ VDC to the mA input. Is the voltage at the S6 side of R19 $\pm 100 m$ VDC?	61	62	
61	Trace the signal path to U8 pin 16.			63
62	Check CR3 and CR4 and trace the signal path to R19.			1
63	Trace the signal path to R4.			
64	The probable cause for a failure that affects only the Diode Test function would be faulty contacts of switch S4.			

Section 5

Lists of Replaceable Parts

5-1. INTRODUCTION

5-2. This section contains an illustrated parts breakdown of the instrument. Components are listed alpha-numerically by assembly. Electrical components are listed by reference designation and mechanical components are listed by item number. Each listed part is shown in an accompanying illustration.

5-3. Parts lists include the following information:

- a. Reference Designation or Item Number.
- b. Description of each part.
- c. Fluke Stock Number.
- d. Federal Supply Code for Manufacturers. (See Appendix A for Code-to-Name list.)
- e. Manufacturer's Part Number or Type.
- f. Total Quantity per assembly or component.
- g. Recommended Quantity: This entry indicates the recommended number of spare parts necessary to support one to five instruments for a period of two years. This list presumes an availability of common electronic parts at the maintenance site. For maintenance for one year or more at an isolated site, it is recommended that at least one in each assembly in the instrument be stocked. In the case of optional subassemblies, plug-ins, etc. that are not always part of the instrument, or are deviations from the basic instrument mode, the REC QTY column lists the recommended quantity of the item in that particular assembly.
- h. Use Code is provided to identify certain parts that have been added, deleted or modified during production of the instrument. Each part for

which a use code has been assigned may be identified with a particular instrument revision letter as in the following example.

F> means Revision F and on.

C-F means Revisions C through F, inclusive.

C means Revisions up through C.

NOTE

The revision letter is located on the circuit board next to the charger/eliminator jack J1.

5-4. HOW TO OBTAIN PARTS

5-5. Components may be ordered directly from the manufacturer by using the manufacturer's part number, or from the John Fluke Mfg. Co., Inc. factory or authorized representative by using the FLUKE STOCK NUMBER. In the event the part you order has been replaced by a new or improved part, the replacement will be accompanied by an explanatory note and installation instructions, if necessary.

5-6. To ensure prompt and efficient handling of your order, include the following information.

- a. Quantity.
- b. FLUKE Stock Number.
- c. Description.
- d. Reference Designation or Item Number.
- e. Printed Circuit Board Part Number.
- f. Instrument Model and Revision Letter.

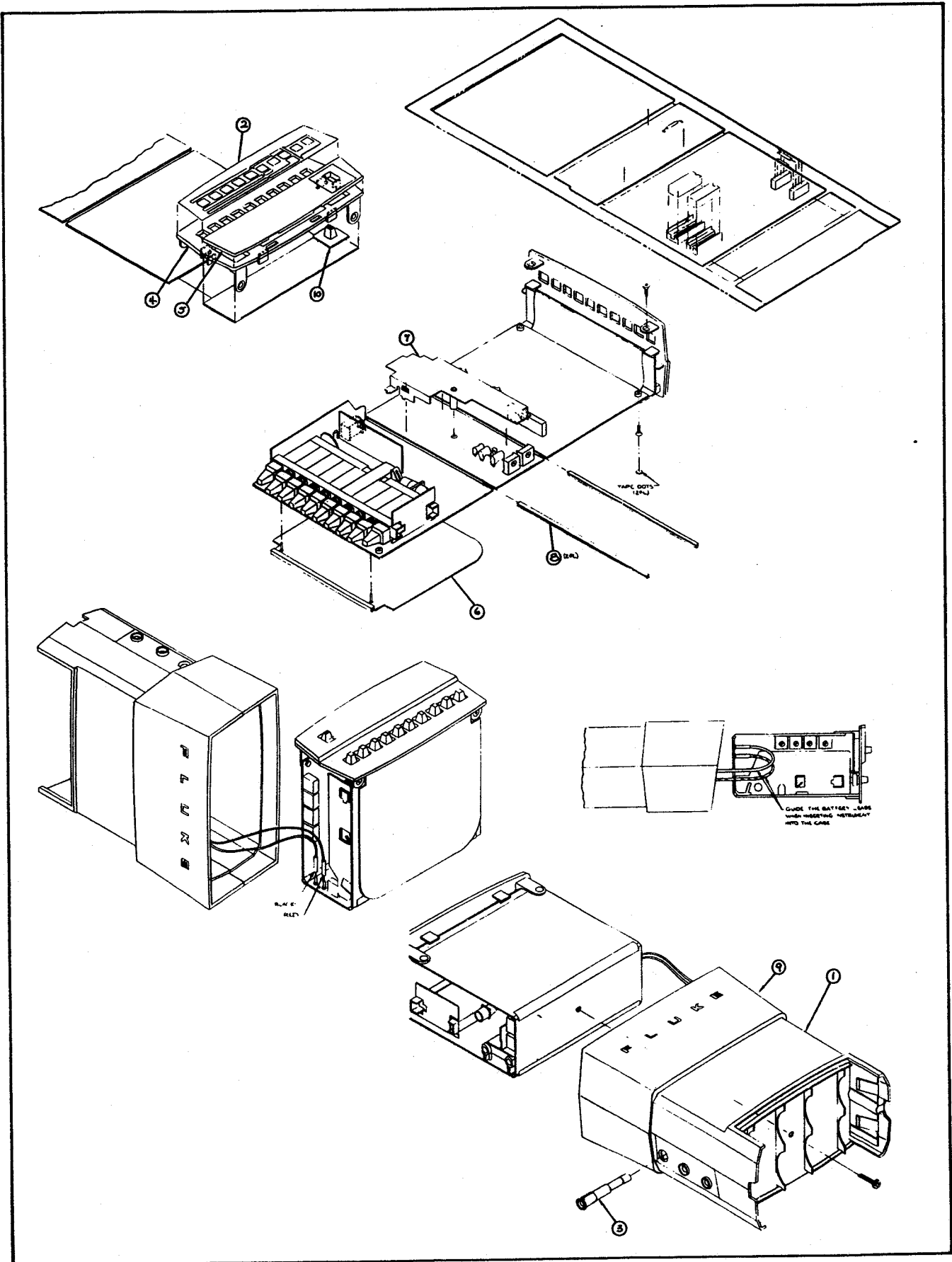

Figure 5-1. Test & Button Up (8030A-7401) (Sheets 1 and 2 of 2)

REF DESIG OR ITEM NO.	DESCRIPTION	FLUKE STOCK NO.	MFG FED SPLY CDE	MFG PART. NO. OR TYPE	TOT QTY	REC QTY	USE CDE
	FINAL ASSEMBLY, MODEL 8030A (Figure 5-1)						
1	Bail Stand	418855	89536	418855	1		
2	Case, molded plastic (without sun shade or battery cover)	426635	89536	426635	1		
F1	Fuse, fast blo, 2 amp	376582	71400	AGX	1		
3	Fuse holder assy	426627	89536	426627	1		
4	Front Panel	426353	89536	426353	1		
5	Lens, display	433227	89536	433227	1		
	Manual, maintenance	425942	89536	425942	1		
	Manual, operator	425934	89536	425934	1		
6	Shield, main pcb, bottom	433235	89536	433235	1		
7	Shield, AC, top	433276	89536	433276	1		
8	Spacer, PCB flexible joints	446468	89536	446468	2		
9	Sun Shade	418673	89536	418673	1		
	Sun Shade, retaining washer	440313	89536	440313	1		
	Sun Shade, screw	320101	89536	320101	1		
10	Button, pwr sw	425975	89536	425975	1		

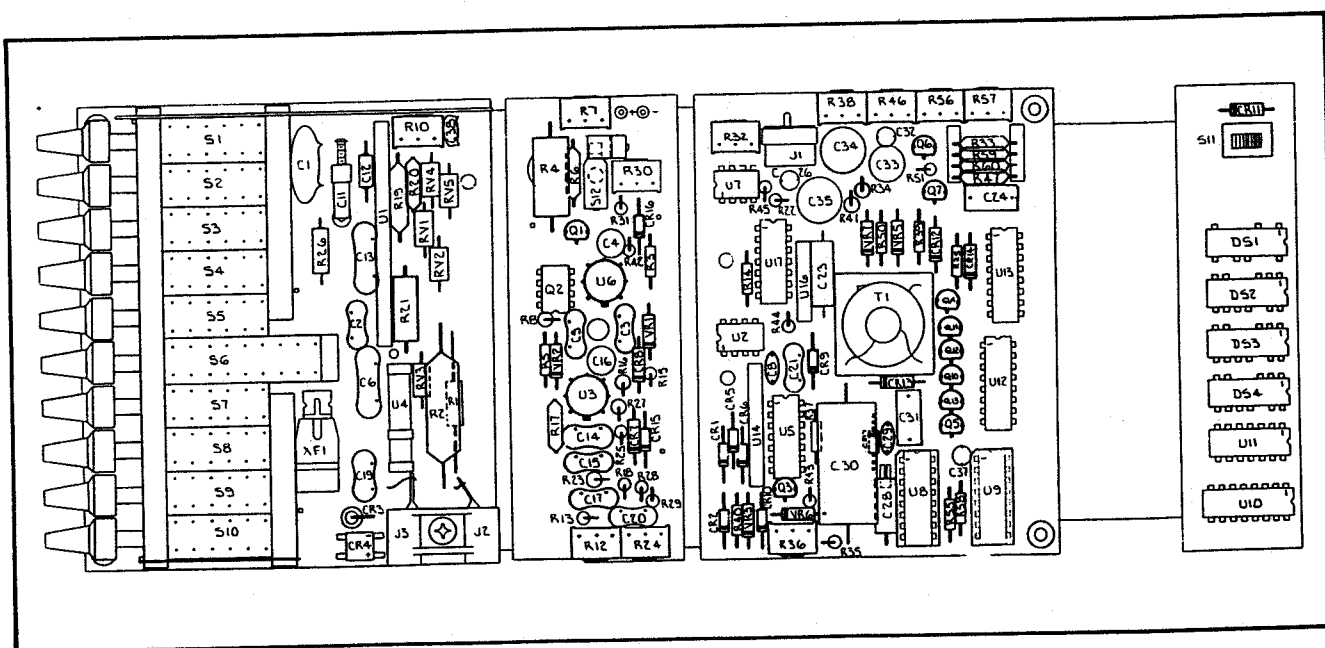









Figure 5-2. Reference Designation, Main Board (8030A-1601)







REF DESIG OR ITEM NO.	DESCRIPTION	FLUKE STOCK NO.	MFG FED SPLY CDE	MFG PART. NO. OR TYPE	TOT QTY	REC QTY	USE CDE
	8030A CIRCUIT BOARD (Figure 5-2)						
C1	Cap, cer, 0.1 uF +80/-20%, 500V	105684	56289	41C92	1		
C2	Not Used						E
C2	Cap, mica, 30 pF +5%, 200V	340570	72136	DM15E300J	1		F>
C3	Cap, mica, 15 pF +5%, 500V	148569	71236	DM15C150J	1		
C4	Cap, elect, 22 uF -10/+75%, 16V	436840	89536	436840	2		
C5	Cap, mica, 22 pF +5%, 500V	148551	72136	DM15C220J	1		
C6	Cap, mica, 820 pF +5%, 500V	148395	53021	D19FD821J03	1		
C7	Not Used						
C8	Cap, ceramic, 50,000 pF +20%, 100V	149161	56289	55C23A1	1		
C9	Not Used						
C10	Cap, mica, 68 pF +10%, 1 kV	148510	72136	DM15F680J	1		
C10	Omitted if C13 is 750 pF						
C11	Cap, var, 1.1 - 1.5, 2000V	435016	72982	530-006	1	1	
C12	Cap, porcelan, 5.1 pF	347948	95275	VY13C5R1C	1		
C13	Cap, mica, 680 pF +1%, 500V	226159	72136	DM19F681F500	1		
C13	Cap, mica 750 pF +1%, 500V (when C10 omitted)	284158	72136	DM19D751F	1		
C14	Cap, mica, 330 pF +5%, 500V	148445	72136	DM15F331J	1		
C15	Cap, mica, 5 pF +10%, 500V	148577	72136	DM15C050K	2		
C16	Cap, elect, 22 uF -10/+75%, 16V	436840	89536	436840	REF		
C17	Cap, mica, 5 pF +10%, 500V	148577	72136	DM15C050K	REF		
C18	Not Used						
C19	Cap, mica, 47 pF +5%, 500V	148536	72136	DM15F470J03	1		
C20	Cap, mica, 100 pF +5%, 500V	148494	72136	DM5FD101F03	1		
C21	Cap, mica, 120 pF +5%, 500V	148486	71236	DM15F121J	1		
C23	Cap, polyester, 0.022 uF +20%, 250V	369165	73445	C281A/A22K	1		
C24	Cap, plste, 0.047 uF +10%, 250V	162008	73445	C280AE/A47K	2		
C25	Not Used						







REF DESIG OR ITEM NO.	DESCRIPTION	FLUKE STOCK NO.	MFG FED SPLY CDE	MFG PART. NO. OR TYPE	TOT QTY	REC QTY	USE CDE
C26	Cap, Ta, 2.2 uF $\pm 20\%$, 20V	161927	56289	196D225X002- HA1	2		
C27	Not Used						
C28	Cap, porcelain, 390 pF $\pm 5\%$						
C29	Cap, ceramic, 5.1 pF ± 0.5 pF, 500V	436790	72982	831-000-S3B- 5190	1		
C30	Cap, pol sulfone, 0.22 uF $\pm 5\%$, 50V						
C31	Cap, plstc, 0.047 uF $\pm 10\%$, 250V	162008	73445	C280AE/A47K	REF		
C32	Cap, Ta, 2.2 uF $\pm 20\%$, 20V	161927	56289	196D225X- 0020HA1	REF		
C33	Cap, elect, 47 uF -10/+75%, 10V	436006	89536	436006	1		
C34	Cap, elect, 220 uF -10/+75%, 16V	435990	89536	435990	2	1	
C35	Cap, elect, 220 uF -10/+75%, 16V	435990	89536	435990	REF		
C36	Not Used						
C37	Cap, Ta, .47 uF $\pm 20\%$, 35V	161349	56289	196D474X- 0035HA1	1		
C38	Cap, ceramic, 10,000 pF $\pm 20\%$	149153	56289	C023B101F103M	1		
CR1	Diode, Si, hi-speed switch	203323	07910	1N4448	9	2	
CR2	Diode, Si, hi-speed switch	203323	07910	1N4448	REF		
CR3	Diode, Si rect	347559	14099	1N5400	1	1	
CR4	Rect, bridge, mini	428151	04713	MDA-922-1	1	1	
CR5	Diode, Si, hi-speed switch	203323	07910	1N4448	REF		
CR6	Diode, Si, hi-speed switch	203323	07910	1N4448	REF		
CR7	Diode, Si, lo-cap, low leakage	348177	07263	FD7223	2	1	
CR8	Diode, Si, lo-cap, low leakage	348177	07263	FD7223	REF		
CR9	Diode, Si, hi-speed switch	203323	07910	1N4448	REF		
CR10	Diode, Si, hi-speed switch	203323	07910	1N4448	REF		
CR11 thru CR14	Diode, Si rect	343491	04713	1N4002	4	1	
CR15	Diode, Si, hi-speed switch	203323	07910	1N4448	REF		

REF DESIG OR ITEM NO.	DESCRIPTION	FLUKE STOCK NO.	MFG FED SPLY CDE	MFG PART. NO. OR TYPE	TOT QTY	REC QTY	USE CDE
CR16	Diode, Si, hi-speed switch	203323	07910	1N4448	REF		
CR17	Diode, Si, hi-speed switch	203323	07910	1N4448	REF		N>
DS1	Display, LED (black package)	418400	29083	03203	1	1	
DS1	Display, LED (white package)	453340	29083	MAN3630	1	1	
DS2 thru DS4	Display, LED (black package)	418392	29083	03202	3	1	
DS2 thru DS4	Display, LED (white package)	453332	29083	MAN3620	3	1	
J1	Jack, DC Power	423897	89536	423897	1	1	
Q1	Xstr, J-FET N-channel	343830	89536	343830	1	1	
Q2	Xstr, Dual, J-FET, N-channel 				1	1	
Q3	Xstr, NPN, Si	168716	07263	ST07154	1	1	
Q4	Not Used						M
Q4	Xstr, Si, NPN	218396	04713	2N3904	3	1	N>
Q5	Xstr, Si, PNP	288761	49956	RS2048	1	1	
Q6	Xstr, Si, NPN	218396	04713	2N3904	REF		
Q7	Xstr, Si, PNP	418707	04713	MPS6562	1	1	
Q8	Not Used						
Q9	Not Used						
Q10	Xstr, Si, PNP	195974	04713	2N3906	3	1	
Q11	Xstr, Si, PNP	195974	04713	2N3906	REF		
Q12	Xstr, Si, PNP	195974	04713	2N3906	REF		
Q13	Xstr, Si, NPN	218396	04713	2N3904	REF		
R1	Res, comp, 100k \pm 10%, 1/2W	108126	01121	EB1011	1		
R2	Res, hv, 9.80k \pm 1%, 3W	423996	89536	423996	1		
R3	Res, comp, 22k \pm 5%, 1/4W	348870	80031	CR251-45P22KT	1		
R4	Res, comp, 100k \pm 10%, 2W	158659	01121	HB1011	1		
R5	Res, car, 6.8k \pm 5%, 1/4W	368761	80031	CR251-45P6R8KT	4		
R6	Res, selected						
R7	Res, var, cermet, 5k \pm 10%, 1/2W	288282	89536	288282	3	1	

REF DESIG OR ITEM NO.	DESCRIPTION	FLUKE STOCK NO.	MFG FED SPLY CDE	MFG PART. NO. OR TYPE	TOT QTY	REC QTY	USE CDE
R8	Res, mf, 75k \pm 1%, 1/8W	291443	91637	MFF1-87502F	1		
R9	Not Used						
R10	Res, var, cermet, 500 \pm 10%, 1/2W	291120	89536	291120	1	1	
R11	Not Used						
R12	Res, var, cermet, 100k \pm 10%, 1/2W	288308	89536	288038	4	1	
R13	Res, comp, 4.7M \pm 5%, 1/4W	220046	01121	CB4755	3		
R14	Res, comp, 3.9M \pm 5%, 1/4W	188417	01121	CB3955	1		
R15	Res, car, 6.8k \pm 5%, 1/4W	368761	80031	CR251-4-5P6R 8KT	REF		
R16	Res, mf, 20.0k \pm 0.1%, 1/8W	446443	91637	MFF1-82002B	3		
R17	Res, mf, 20.0k \pm 0.1%, 1/8W	446443	91637	MFF1-82002B	REF		
R18	Rex, car, 20k \pm 5%, 1/4W	441477	80031	CR251-4-5P20KT	1		
R19	Res, mf, 899.1 \pm 0.1%, 1/4W	424275	91637	MFF1-48R991B	1		
R20	Res, mf, 89.9 \pm 0.25%, 1/8W	423871	91637	MFF1-889R9D	1		
R21	Res, ww, 8.991 \pm 0.25%, 3W	441121	89536	441121	1	1	
R22	Res, comp, 4.7M \pm 5%, 1/4W	220046	01121	CB4755	REF		
R23	Res, mf, 10.0k \pm 0.1%, 1/8W	343459	91637	MFF1-81002B	1		
R24	Res, var, cermet, 100k \pm 10%, 1/2W	288308	89536	288308	REF		
R25	Res, car, 10k \pm 5%, 1/4W	348839	80031	CR251-4-5P10KT	2		
R26	Res, comp, 120 \pm 10%, 1/2W	108969	01121	EB1211	1		
R27	Res, mf, 20.0k \pm 0.1%, 1/8W	446443	91637	MFF1-82002B	REF		
R28	Res, car, 3.3k \pm 0.25%, 1/4W	348813	80031	CR251-4-5P3R- 3KT	1		
R29	Res, car, 18k \pm 5%, 1/4W	348862	80031	CR251-4-5P18- KT	2		
R30	Res, var, cermet, 100k \pm 10%, 1/2W	288308	89536	288308	REF		
R31	Res, comp, 4.7M \pm 5%, 1/4W	220046	01121	CB4755	REF		
R32	Res, var, cermet, 5k \pm 10%, 1/2W	288282	89536	288282	REF		
R33	Res, selected						
R34	Res, mf, 35.7k \pm 0.25%, 1/8W	446427	91637	MFF1-83572D	1		

REF DESIG OR ITEM NO.	DESCRIPTION	FLUKE STOCK NO.	MFG FED SPLY CDE	MFG PART. NO. OR TYPE	TOT QTY	REC QTY	USE CDE
R35	Res, mf, 23.2k \pm 1%, 1/8W	291351	91637	MFF1-82322F	1		
R36	Res, var, cermet, 5k \pm 10%, 1/2W	288282	89536	288282	REF		
R37	Res, car, 470k \pm 5%, 1/4W	342634	80031	CR251-4-5P470 KT	1		
R38	Res, var, cermet, 100k \pm 10%, 1/2W	288308	89536	288308	REF		
R39	Res, car, 82k \pm 5%, 1/4W	348912	80031	CR251-4-5P82KT	1		
R40	Res, car, 1 \pm 5%, 1/4W	357665	80031	CR251-4-5P10HM	1		
R41	Res, mf, 10.0k \pm 0.25%, 1/8W	446435	91637	MFF1-81002D	1		
R42	Res, car, 15k \pm 5%, 1/4W	348854	80031	CR251-4-5P15- KT	1		
R43	Res, mf, 6.49k \pm 1%, 1/8W	294900	91637	MFF1-86491F			
R44	Res, car, 6.8k \pm 5%, 1/4W	368761	80031	CR251-4-5P6R 8KT	REF		
R45	Res, car, 6.8k \pm 5%, 1/4W	368761	80031	CR251-4-5P6R 8KT	REF		
R46	Res, var, cermet, 20k \pm 10%, 1/2W	291609	89536	291609	1	1	
R47	Res, selected						
R48	Not Used						
R49	Not Used						
R50	Res, car, 18k \pm 5%, 1/4W	348862	80031	CR251-4-5P18KT	REF		
R51	Res, car, 220 \pm 5%, 1/4W	342626	80031	CR251-4-5P470 KT	1		
R52	Res, car, 10k \pm 5%, 1/4W	348839	80031	CR251-4-5P10KT	REF		
R53	Not Used						
R54	Not Used						
R55	Res, car, 150k \pm 5%, 1/4W	348938	80031	CR251-4-5P150 KT	1		
R56	Res, cermet, 1k \pm 10%, 1/2W	285155	89536	285155	1	1	
R57	Res, cermet, 100 \pm 10%, 1/2W	285130	89536	285130	1	1	
R58	Res, car, 3.9k \pm 5%, 1/4W	342600	80031	CR251-4-5P-3R 9KT	1		
R59	Res, selected						

REF DESIG OR ITEM NO.	DESCRIPTION	FLUKE STOCK NO.	MFG FED SPLY CDE	MFG PART. NO. OR TYPE	TOT QTY	REC QTY	USE CDE
R60	Res, selected						
RV1 thru RV5	Varistor	423475	04290	V390MA6B	5	1	
S1 thru S10	Switch Assy	426452	89536	426452	1	1	
S11	Switch, slide, dpdt	452862	89536	452862	1	1	
T1	Xfmr, dc-dc, converter	423590	89536	423590	1		
U1	Res Network	416966	89536	416966	1	1	
U2	IC, linear, op-amp, dual	418566	12040	LM358N	2	1	
U3	IC, op-amp	352930	18324	LM301A	2	1	
U4	Res Network	423905	89536	423905	1	1	
U5	IC, quad switch 	428466	89536	428466	1	1	
U6	IC, op-amp	352930	18324	LM301A	REF		
U7	IC, linear, op-amp, dual	418566	12040	LM358N	REF		
U8	IC, analog 						
U9	IC, digital 	418814	89536	418814	1	1	
U10	IC, digital, Schottky, 7-seg, decoder/driver	418632	01295	SN74LS47N	1	1	
U11	Res Network	423426	89536	423426	1	1	
U12	IC, linear NPN 5-xstr array	418574	95303	CA3083E	1	1	
U13	Res Network	423434	89536	423434	1	1	
U14	Res Network	435107	89536	435107	1	1	
U15	Not Used						
U16	Res Network	435081	89536	435081	1	1	
U17	IC, xstr array						
VR1	Diode, zener	453019	07910	1N5235	2	1	
VR2	Diode, zener	453019	07910	1N5235	REF		
VR3	Diode, zener	453118	07910	1N5245	2	1	
VR4	Diode, zener	454074	71590	1N5237B	1	1	M
VR4	Not used						N>

REF DESIG OR ITEM NO.	DESCRIPTION	FLUKE STOCK NO.	MFG FED SPLY CDE	MFG PART. NO. OR TYPE	TOT QTY	REC QTY	USE CDE
VR5	Diode, zener				1	1	
VR6	Diode, zener	330829	07910	1N4571	1	1	
VR7	Diode, zener	453118	07910	1N5245	REF		
XU8, XU9	Socket, IC, 16 pin	276535	91506	316-AG39D	2		
1	Spring Contact, fuse	418491	89536	418491	1		
2	Guide fuse (FX1)	438119	89536	438119	1		
3	Shield, input	438002	89536	438002	1		
4	Connector, flex 0.35 inch	433631	89536	433631	2		
5	Connector, flex 1.35 inch	433649	89536	433649	1		
6	Receptacle, test lead	434902	89536	434902	1		
7	Strap, charger/eliminator hold down	457713	89536	457713	1		
	Button, Function	425900	89536	425900	5		
	Button, Range	426759	89536	426759	5		
	Shield, SW	449835	89536	449835	1		
	Socket, 5 contact in line	417899	52072	CA-05S-TSD	2		
	Socket, comp, lead	441279	00779	2-332070-4	4		
	Connector, post	376574	00779	3-87022-1	6		
	<p> Indicates MOS device which may be damaged by static discharge</p> <p> C28, C30, R47, R59, R60, VR5 and U8 are a matched set. Order part no. 451625.</p> <p> R33 and U17 are a matched set. Order part no. 451633.</p> <p> R6 and Q2 are a matched set. Order part no. 451641. Order part no. 459438</p>						
							

Section 6

Option & Accessory Information

6-1. INTRODUCTION

6-2. This section of the manual contains information pertaining to the options and accessories available for your instrument. Each of the options and accessories are described under separate major headings containing the model or option number. The option descriptions contain applicable operating and maintenance instruction, and field installation procedures. Replaceable parts and schematics for all options are given in Sections 5 and 7, respectively.

6-3. RECHARGEABLE BATTERY PACK, 8040A-7005

6-4. Introduction

6-5. The rechargeable battery pack, item ① in Figure 6-1, is recommended when the 8030A is to be used extensively as a portable multimeter. Four nickel cadmium (Ni-cad) batteries allow typically 8-hours of portable operation before they require recharging. The batteries may be recharged, in about 14 hours, by connecting the Charger/Eliminator accessory to the 8030A with the instrument's power switch in OFF position.

6-6. Operation

6-7. The battery pack, as delivered, has four Ni-cad batteries mounted to an 8030A battery cover. One of the battery retainers that secure the batteries to the cover has a peg extending from it that mates with a hole in the back of the 8030A. The peg, when the battery pack is in place on the 8030A, closes the charging path allowing the batteries to be recharged. Recharge the batteries as follows:

1. Connect the charger/eliminator to the BATTERY jack on the left side of the 8030A.

2. Turn the 8030A POWER switch to the OFF position.
3. Allow at least 14 hours for recharging a discharged battery pack.

NOTE

Recharge the batteries when the battery test ($V-\Omega$ test lead inserted into the BTRY TEST jack) indicates 4.4 volts.

6-8. BATTERY COVER KIT, 8040A-7004

6-9. The Battery Cover Kit consists of the molded plastic battery cover and four "C" size alkaline batteries (not rechargeable). The kit is provided for those who may wish to convert an 8030A equipped with the rechargeable Ni-cad batteries to use the less expensive alkaline batteries. These alkaline batteries will typically provide 10 hours of operation before they need replacing.

NOTE

The charging circuit can not be activated when the 8040A-7004 battery cover is installed. The charger/eliminator can be used as a power source when the alkaline batteries are in place.

6-10. BATTERY COVER, 8040A-7007

6-11. This accessory is intended to be a replacement cover for lost or damaged battery covers. The cover does not include the battery retainers used to secure the rechargeable Ni-cad batteries to the cover.

6-12. CARRYING CASE (C88)

6-13. The Model C88 Carrying Case, item ② in Figure 6-1, is a soft vinyl container designed to provide protection for the 8030A multimeter as well as increased



Figure 6-1. 8030A Accessories

convenience during portable operation. A detachable storage pouch provides room for test leads, spare batteries, the operators manual and small accessories.

6-14. BATTERY CHARGER/ELIMINATOR

6-15. The Battery Charger/Eliminator, item ③ in Figure 6-1, may be ordered in one of four input power configurations. Each power configuration has a unique model number which must be used when ordering this accessory. Refer to Table 6-1 for the description of each model number.

Table 6-1. Battery Charger/Eliminator Input Power Configurations

MODEL NO.	INPUT POWER
A81-100	100V ac, 48 to 62 Hz
A81-115	115V ac, 48 to 62 Hz
A81-220	220V ac, 48 to 62 Hz (U.K. type plug) (BS1363)
A81-230-1	230V ac, 48 to 62 Hz (U.S. type plug)
A81-230	230V ac, 48 to 62 Hz (European type plug CEE7)
A81-230-3	240V ac, 48 to 62 Hz (European type plug CEE7)

6-16. TEMPERATURE PROBE (80T-150)

6-17. Introduction

6-18. The Model 80T-150 Temperature Probe is a self-contained temperature-to-voltage converter. It is designed to provide a direct temperature reading on the display of any high impedance voltmeter ($>1\text{ M}\Omega$) capable of 1 mV resolution, and at least 300 full-scale readout. The probe can be configured to provide either one of two temperature displays; -50 to $+150^\circ\text{C}$ or -58 to $+300^\circ\text{F}$.

6-19. Operating power for the probe is provided by an internal lithium battery. Typically, the battery will provide up to 1000 hours of continuous operation before replacement is necessary. An ON/OFF switch is provided to conserve the battery when the probe is not in use.

6-20. Operating Notes

6-21. PROBE LIMITATIONS

6-22. The 80T-150 probe is constructed of highly durable plastic and is suitable for measuring the temperature of liquids, gases and solids up to 150°C . When making the temperature measurements, observe the following precautions to prevent damage to the probe:

1. Do not expose the probe end (probe tip plus 2 inches of probe body) to temperatures in excess of $+150^\circ\text{C}$. The remainder of the probe body should not be exposed to temperatures above $+70^\circ\text{C}$.
2. Most corrosive agents will not damage the probe body. However, the aluminum probe tip will deteriorate under long term exposure to corrosive environments.

CAUTION

Long term exposure of the probe to corrosive environments will result in pitting and deterioration of the aluminum probe tip.

6-23. MEASUREMENT ERROR SOURCES

6-24. Techniques used when making the temperature measurements can affect the accuracy of the reading. The following information will aid in making more accurate temperature measurements.

1. When the probe tip is applied to a solid surface it draws or sinks heat from the surface. Therefore, if the measured surface has a low mass (e.g., a transistor case), the indicated temperature may be lower than the actual temperature.
2. Similarly, a steady-state error or gradient exists between the measured surface and the sensing device in the probe tip. This is due to the flow of heat from the measurement surface to the probe body. The effect of the steady-state error increases as the differential between ambient and surface temperature increases.
3. To determine the actual surface temperature of a device, both the heat-sinking and steady-state errors must be considered. The correction curve given in Figure 6-2 approximates the effect of both error sources on TO-3, TO-5 and TO-18 transistor cases.
4. RF signals applied to the 80T-150 probe tip can also cause errors in temperature measurement. Figure 6-3 defines the rf signal limits that can be tolerated without degrading measurement accuracy.

6-25. Operating Instructions

6-26. The following instructions should be adhered to in order to obtain the best results from the 80T-150 probe.

1. Connect the banana plugs on the 80T-150 to the V- Ω and COMMON input terminals. Observe polarity.
2. Select the DCV, 200 mV range on the 8030A.
3. Set the 80T-150 power switch to the ON position and energize the 8030A.
4. Firmly touch the probe tip to the surface to be measured, or expose it to the gas or liquid. The 8030A will display the temperature in degrees. Vary the probe angle and pressure when measuring solid surface temperatures; the highest stable reading will be the most accurate.

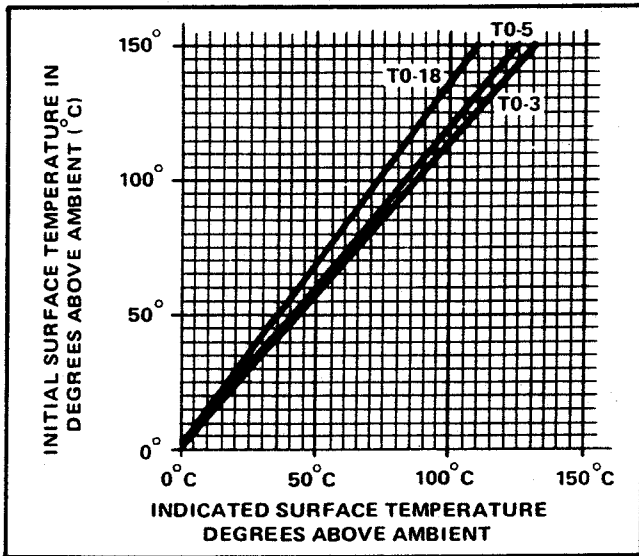

Figure 6-2. Initial Case Temperature Above Ambient vs. Meter Reading Above Ambient

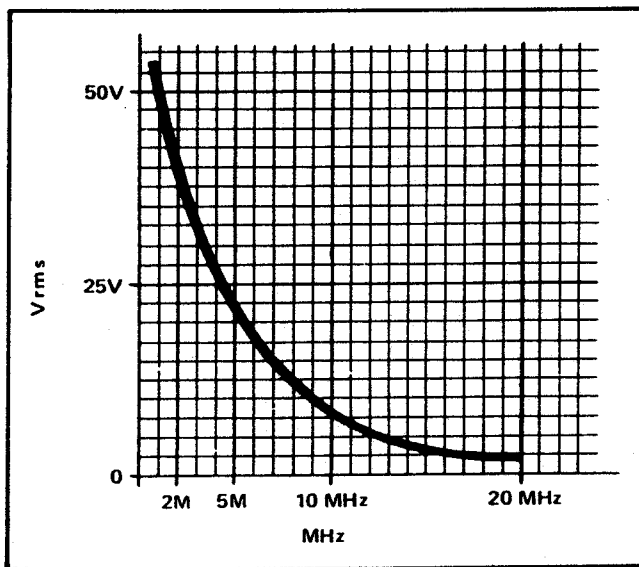

Figure 6-3. Maximum RF Signal Limits (V RMS) at Probe Tip

CAUTION

The force exerted on the probe tip should not exceed 20 pounds.

6-27. DELUXE TEST LEAD KIT (A80)

6-28. The deluxe test lead kit, shown in Figure 6-4, contains two test leads with probes (red and black), and five pairs of universal probe tips. The probe tips include: alligator clips, test probe tips, pin tips, banana plug tips, and binding post lugs. A convenient plastic pouch is provided for storing the contents of the test lead kit.

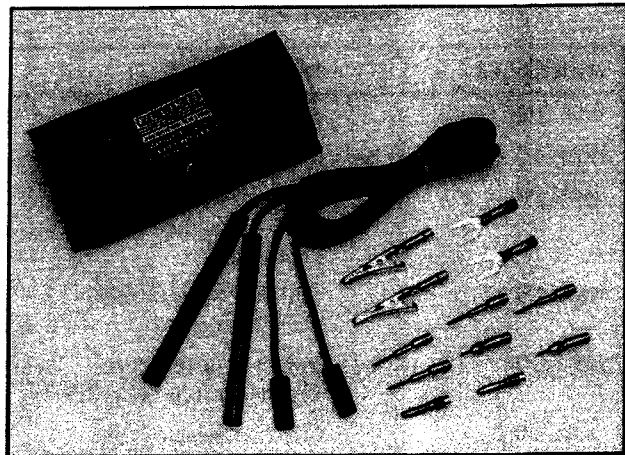

Figure 6-4. Deluxe Test Lead Kit

6-29. CURRENT TRANSFORMER, CLAMP-ON (801-600)

6-30. Introduction

6-31. The Model 801-600, as shown in Figure 6-5, is a clamp-on current transformer which is used to extend the current measurement capabilities of the 8030A. The probe is designed to measure current of 2 to 600 amperes at frequencies of up to 1 kHz with +3% accuracy. The clamp-on feature allows current to be measured without breaking the circuit under test.

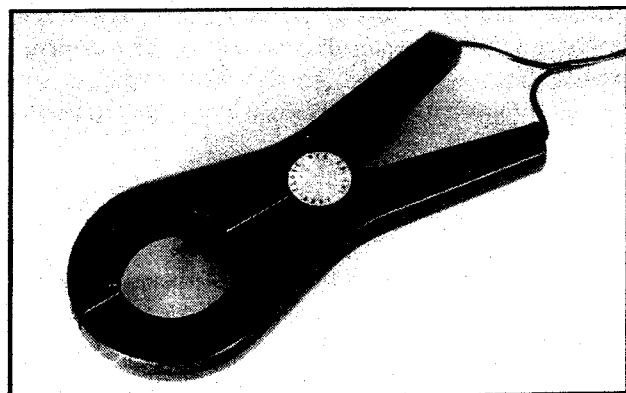

Figure 6-5. 801-600 Current Probe

6-32. Operation

6-33. Use the following procedure for operating the 8030A with the 80I-600 transformer:

- Plug the 80I-600 dual-banana plug into the mA and COMMON input terminals on the 8030A.
- Depress the AC and mA pushbuttons.
- Select the desired current range in accordance with Table 6-2.
- Clamp 80I-600 around current carrying conductor to be measured.
- Observe ac current reading in amperes on the 8030A readout.

NOTE

Clamping the 80I-600 around more than one current carrying conductor at a time procedurs a reading that is the vector sum of the currents in the conductors.

Table 6-2. 8030A Ranges for Current Transformer (80I-600)

8030A RANGE SELECTED	8030A CURRENT RANGE WITH 80I-600 TRANSFORMER
2000	200A to 600A
200	20A to 200A
20	2A to 20A

6-34. CURRENT SHUNT (80J-10)

6-35. The Model 80J-10 Current Shunt shown in Figure 6-6 directly mates to the input terminals of the Fluke voltmeters. Current measurements may be made up to 10 Amps continuous (20 Amps for periods not exceeding one minute) DC to 10 kHz. Accuracy with the Current Shunt is \pm (the accuracy of the meter + .25%).

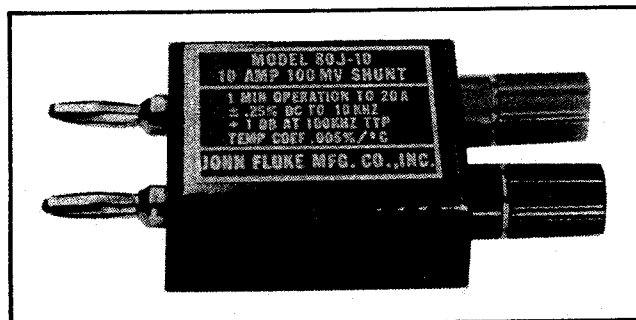

Figure 6-6. 80J-10 Current Shunt

6-36. HIGH VOLTAGE PROBE (80F-5)

6-37. Introduction

6-38. The Model 80F-5 Voltage Divider shown in Figure 6-6, allows measurement of up to 5k volts dc to be made using FLUKE 800, 900 and 8000 series voltmeters. Division ratio of this accessory is 1000:1. Accuracy and stability of the division ratio is ensured using special metal film resistors having matched temperature coefficients.

6-39. Physical design of the Model 80F-5 allows direct mating to the input terminals of the FLUKE voltmeters. A high voltage probe facilitates connection to the measurement source. Maintenance is minimized by encapsulation of the divider components.

6-40. Three versions of the Model 80F-5 are available. The basic Model 80F-5 is used with voltmeters having a 10 megohm input resistance. An (01) Option is provided for voltmeters having an 11 megohm input resistance, and an (02) Option is provided for voltmeters having an infinite input resistance (10^9 megohms or greater) at null.

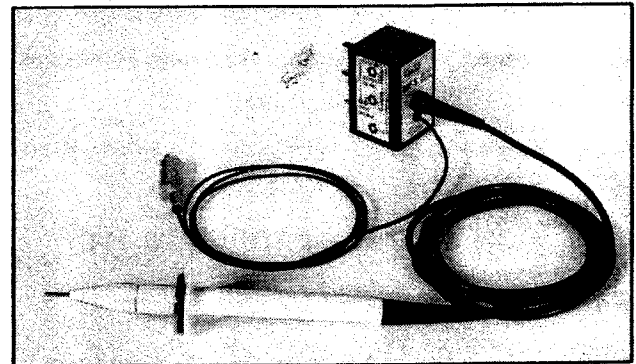

Figure 6-7. 80F-5 Voltage Divider

6-41. Cleaning

6-42. Accumulation of dust or dirt particles between the output terminals of the Model 80F-5 can be removed using clean dry pressurized air. Stubborn particles can be removed following an application of isopropyl alcohol.

6-43. Calibration

6-44. The Model 80F-5 division ratio should be checked every month or every year depending on the accuracy requirement. Ratio accuracy stability is specified at +0.01% per month and +0.05% per year. Calibration should be accomplished only after the Model 80F-5 has been in non-operating state for at least four hours at a temperature of 23°C.

6-45. Test equipment requirements are a stable 1000 volt dc source such as the FLUKE Model 332B Voltage Calibrator and the FLUKE voltmeter. To calibrate the Model 80F-5 perform the following steps:

NOTE

The input resistance of the voltmeter must reach that of the 80F-5.

- a. Calibrate the FLUKE voltmeter.
- b. Install the Model 80F-5 on the FLUKE voltmeter input terminals.
- c. Unscrew the strain relief on the input cable of the Model 80F-5 and remove the front cover.
- d. Select the appropriate dc voltage range on the FLUKE voltmeter.
- e. Apply 1000 volts dc to the Model 80F-5 high voltage probe.
- f. Adjust the variable resistor on the Model 80F-5 for a 1.0 volt dc indication on the FLUKE voltmeter.
- g. Remove the voltage from the Model 80F-5 high voltage probe.
- h. Install the Model 80F-5 front cover and strain relief.

6-46. HIGH VOLTAGE PROBE (80F-15)

6-47. Introduction

6-48. The Accessory Model 80F-15 Voltage Divider, shown in Figure 6-8, allows measurement of up to 15k volts dc to be made using FLUKE 800, 900, and 8000 series voltmeters. Division ratio of this accessory is 1000:1. Accuracy and stability of the division ratio is ensured using special metal film resistors having matched temperature coefficients.

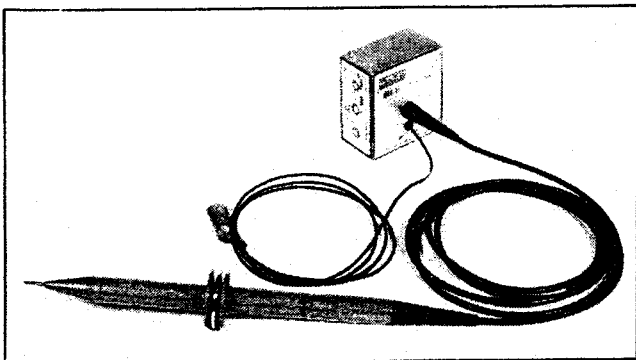

Figure 6-8. 80F-15 Voltage Divider

6-49. Physical design of the Model 80F-15 allows direct mating to the input terminals of the FLUKE voltmeters. A high voltage probe facilitates connection to the measurement source. Maintenance is minimized by encapsulation of the divider components.

6-50. Three versions of the Model 80F-15 are available. The basic Model 80F-15 is used with voltmeters having a 10 megohm input resistance. An (01) Option is provided for voltmeters having an 11 megohm input resistance, and an (02) Option is provided for voltmeters having an infinite input resistance (10^3 megohm or greater) at null.

6-51. Cleaning

6-52. Accumulation of dust or dirt particles between the output terminals of the Model 80F-15 can be removed using clean dry pressurized air. Stubborn particles can be removed following an application of isopropyl alcohol.

6-53. Calibration

6-54. The Model 80F-15 division ratio should be checked every month or every year depending on the accuracy requirement. Ratio accuracy stability is specified at $\pm 0.01\%$ per month and $\pm 0.05\%$ per year. Calibration should be accomplished only after the Model 80F-15 has been in the non-operating state for at least four hours at a temperature of 23°C.

6-55. Test equipment requirements are a stable 1000 volt dc source such as the FLUKE Model 332B Voltage Calibrator and the FLUKE voltmeter. To calibrate the Model 80F-15, perform the following steps:

NOTE

The input resistance of the voltmeter must match that of the 80F-15. See paragraph, REQUIRED VOLTMETER INPUT RESISTANCE, under specifications.

- a. Calibrate the FLUKE voltmeter.
- b. Install the Model 80F-15 on the FLUKE voltmeter input terminals.
- c. Unscrew the strain relief on the input cable of the Model 80F-15 and remove the front cover.
- d. Select the appropriate dc voltage range on the FLUKE voltmeter.
- e. Apply 1000 volts dc to the Model 80F-15 high voltage probe.
- f. Adjust the variable resistor on the Model 80F-15 for a 1.0 volt dc indication on the FLUKE voltmeter.

- g. Remove the voltage from the Model 80F-15 high voltage probe.
- h. Install the Model 80F-15 front cover and strain relief.

6-56. HIGH VOLTAGE PROBE (80K-40)

6-57. Introduction

6-58. The Accessory Model 80K-40 Voltage Divider, shown in Figure 6-9, allows measurement of up to 40k volts dc to be made using FLUKE 8000 series voltmeters. Division ratio of this accessory is 1000:1. Accuracy and stability of the division ratio is ensured using special metal film resistors having matched temperature coefficients.

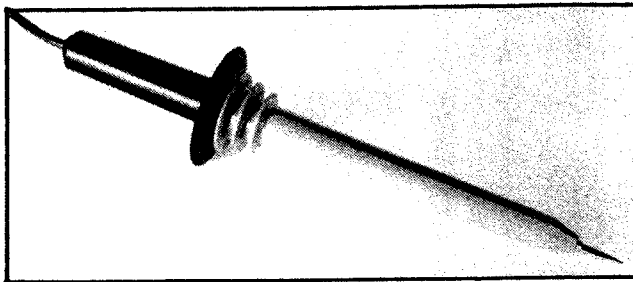

Figure 6-9. 80K-40 Voltage Divider

6-59. Physical design of the Model 80K-40 allows direct mating to the input terminals of the FLUKE voltmeters. A high voltage probe facilitates connection to the measurement source. Maintenance is minimized by encapsulation of the divider components.

6-60. HIGH FREQUENCY PROBE (81 RF)

6-61. Introduction

6-62. The Model 81RF High Frequency Probe, Figure 6-10, extends the frequency range of the DVM/DMM to include 100 kHz to 100 MHz for ac voltage measurements from 0.25 to 30V rms. The 81RF operates in conjunction with the dc voltage ranges, and is connected to the DVM/DMM using a shielded dual-banana plug and, when necessary, a dual banana adaptor.

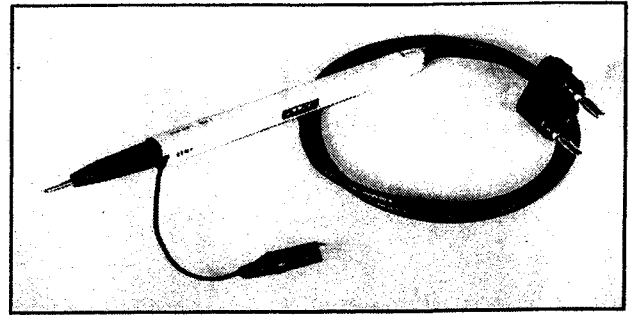

Figure 6-10. 81 RF High Frequency Probe

6-63. HIGH FREQUENCY PROBE (82RF)

6-64. Introduction

6-65. The Model 82RF High Frequency Probe, Figure 6-11, allows measurements over a frequency range of 100 kHz to 500 MHz from 0.25 to 30V rms. It is designed to be used with voltmeters having an input impedance of 10 megohms +10%. It may be used with a voltmeter having an input impedance higher than 10 megohms provided the input is externally shunted to make the equivalent input impedance equal to 10 megohms.

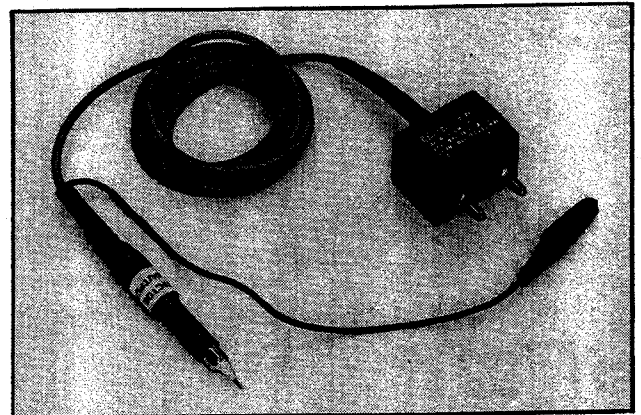
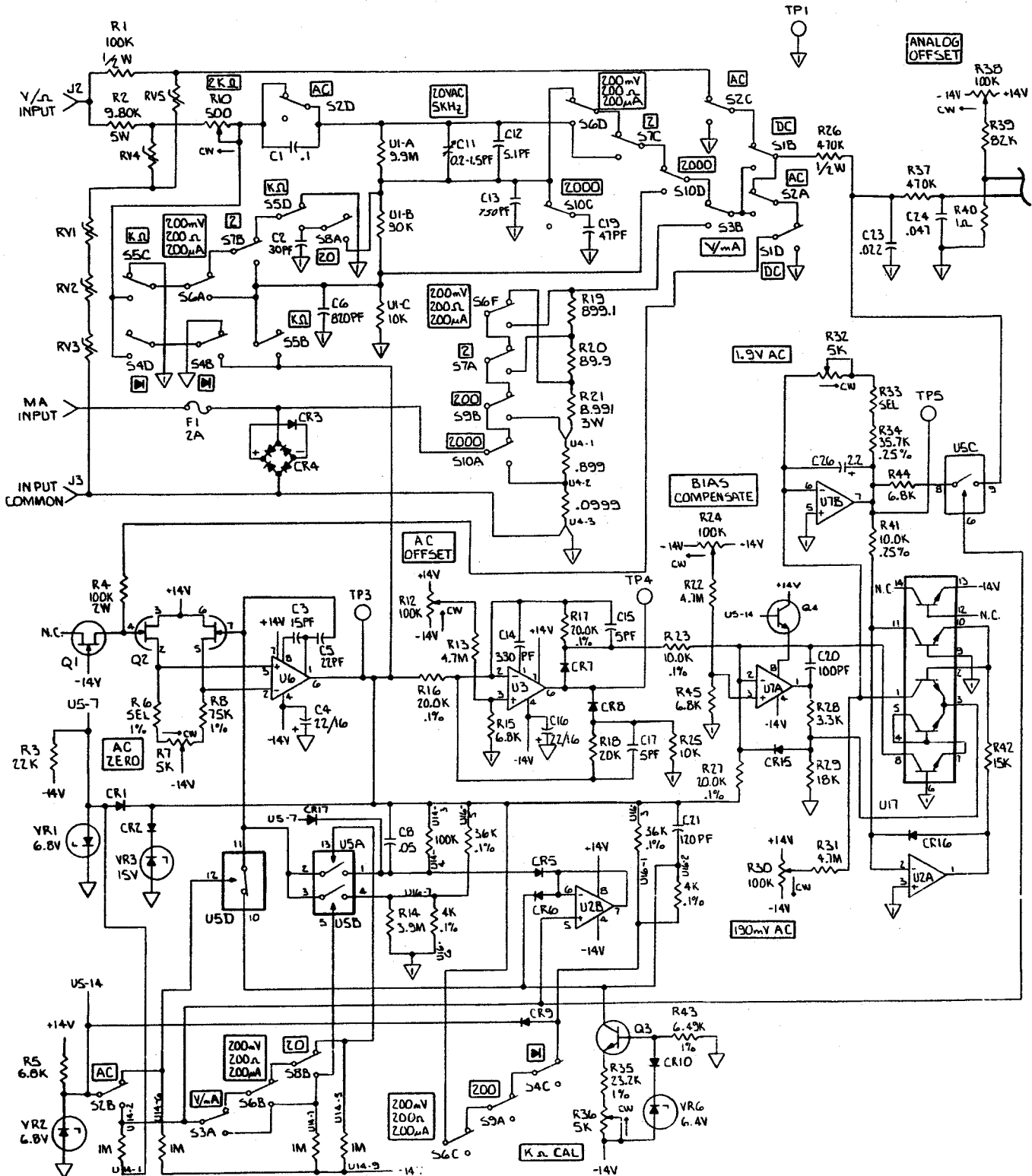

Figure 6-11. 82 RF High Frequency Probe

6-66. Circuitry within the 82RF consists of a capacitor-coupled rectifier circuit which responds to the peak value of the input waveform. The output is positive polarity dc which is calibrated to be equivalent to the rms value of a sine wave.

Section 7

Schematic Diagram



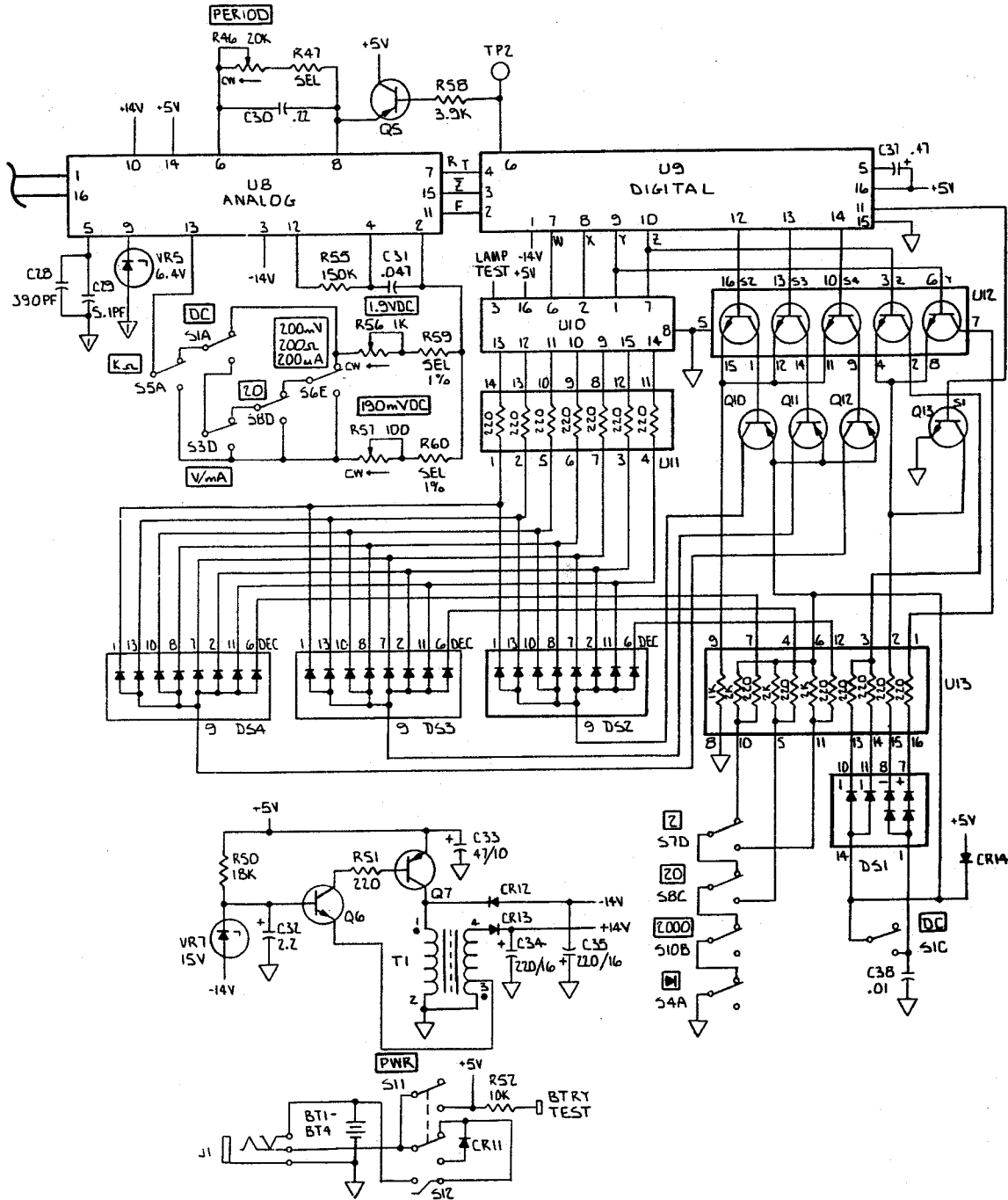

Figure 7-1. Computing RMS Multi-Meter (8030A-1001)

CHANGE/ERRATA INFORMATION

ISSUE NO: 7

5/81

This change/errata contains information necessary to ensure the accuracy of the following manual. Enter the corrections in the manual if either one of the following conditions exist:

1. The revision letter stamped on the indicated PCB is equal to or higher than that given with each change.
2. No revision letter is indicated at the beginning of the change/errata.

MANUAL

Title: 8030A MAINTENANCE MANUAL
Print Date: August 1976
Rev. and Date: 2 - 6/77

C/E PAGE EFFECTIVITY

Page No.	Print Date
1	2/79
2	10/79
3	5/81
4	5/81

ERRATA #1

On page 5-10, correct the description of item 2 to read:
Guide, fuse (XF1).

CHANGE #1 - 11024

On page 5-2:

ADD: F2|Fuse, 3 amp|460915|71400|GFA3|1|5

On page 7-2:

Add a fuse symbol between BT1, BT2, and BT3, and BT4, label it "F2,3A"

CHANGE #2 - 11116

Rev.- R, 8030A Circuit Board (8030A-4001)

On page 5-5:

Change the TOT QTY of C26, FROM: 2 TO: 3

ADD: C39|Cap, TA, 2.2 uF $\pm 20\%$, 20V|161927|56289|196D2225X0020HA1|1

On page 7-1:

Add a 2.2 uF cap (C39) across the 6.8V zener diode (VR2).

Show positive side of cap connected to junction of R5-VR2, and negative side to common.

ERRATA #2

On page 1-2, Table 1-6, under DC Voltage:

FROM: Maximum Input.....1100V dc or peak ac (<10 sec. on 200 mV, 2V ranges)

TO: Maximum Input.....750V rms or 1100V peak, not to exceed 10^7 volt-Hz product (L/O sec. on 200 mV, 2V ranges).

CHANGE #3 - 11832

Rev.- T, 8030A Circuit Board (8030A-4001)

On page 5-4:

FROM: C13|Cap, Mica, 750 pF $\pm 1\%$, 500V|284158|72136|DM19D751F|1

TO: C13|Cap, Mica, 820 pF $\pm 5\%$, 500V|148395|72136|DM19FD821J|REF

Change TOT QTY of C6, FROM: 1 TO: 2

On page 7-1:

Change value of C13, FROM: 750 pF, TO: 820 pF

CHANGE #4 - 11850

Rev.- U, 8030A Circuit Board (8030A-4001)

On page 5-6:

FROM: S11|Switch, slide, dpdt|452862|89536|452862|1|1

TO: S11|Switch, slide, dpdt|423129|89536|423129|1|1

CHANGE #5 - 11861

Rev.- V, 8030A Circuit Board (8030A-4001)

On page 5-9:

FROM: DS1|Display LED (Wht. Pkg)|453340|29083|MAN3630|1|1

TO: DS1|Display LED (Wht. Pkg)|495457|285457|QDSP3507|1|1

FROM: DS2-DS4|Display LED (Wht. Pkg.)|453332|29083|MAN3620|3|1

TO: DS2|DS4|Display LED (Wht. Pkg.)|495440|28480|QDSP3515|3|1

CHANGE #6 - 12337

Rev.- W, 8030A Circuit Board (8030A-4001)

On page 5-6:

FROM: Q7|Xstr, Si, PNP|418707|04713|MPS6562|1|1

TO: Q7|Xstr, Si, PNP|523647|04713|MPS6651|1|1

CHANGE #7 - 12624

Rev.- X, 8030A Circuit Board (8030A-4001)

Documentation change, does not affect manual.

ERRATA #3

On page 5-6:

When ordering Fluke Part No: 288761, be aware that it may be installed one of two ways, depending upon the manufacturer;

1. The clocking for the NPS404 is:



2. The clocking for the KA6808 is:



ERRATA #4

On page 2-3:

Add the following note under para. 2-17:

NOTE

The 8030A transient overload protection circuit is intended to protect against short duration high energy pulses. The components used are limited to approximately five (5) 6 kV 10 microsecond pulses per second or about 0.6 watts average. Fast rep rate pulses as from a TV set can damage the protection components; RV1 thru RV4, R1 and R2. Use only Fluke replacement parts to maintain product safety.

CHANGE #8 - 13211

Rev.-X, 8030A Circuit Board (8030A-4001)

Documentation change, does not affect manual.

CHANGE #9 - 13276

Rev.-X, 8030A Circuit Board (8030A-4001)

On page 5-10:

CHANGE: 4|Connector, flex 0.35 inch|433631|89536|433631|1

TO: 4|Connector, no-mex flex|525022|89536|525022|1

CHANGE: 5|Connector, flex 1.35 inch|433649|89536|433649|1

TO: 5|Connector, no-mex flex|525030|89536|525030|1

ERRATA #5

On page 2-4, para. 2-21 step g:

Change line 6, FROM: as much as 60 millivolts (Battery operation) or 130 mV, TO: as much as 95 millivolts (Battery operation) or 195 mV.

CHANGE #10 - 13666

Rev.-Z, 8030A Circuit Board (8030A-4001)

On page 5-9:

CHANGE: S11|Switch, slide, dpdt|452862|89536|452862|1|1

TO: S11|Switch, slide, dpdt|572016|89536|572016|1|1

ERRATA #6

On page 7-1:

Change schematic drawing of Q2 as shown below:

